

OPERATOR'S GUIDE

PowerScout™ HD Networked Power Meters

PowerScout™ 3 HD ▪ PowerScout™ 12 HD ▪ PowerScout™ 24 HD ▪ PowerScout™ 48 HD

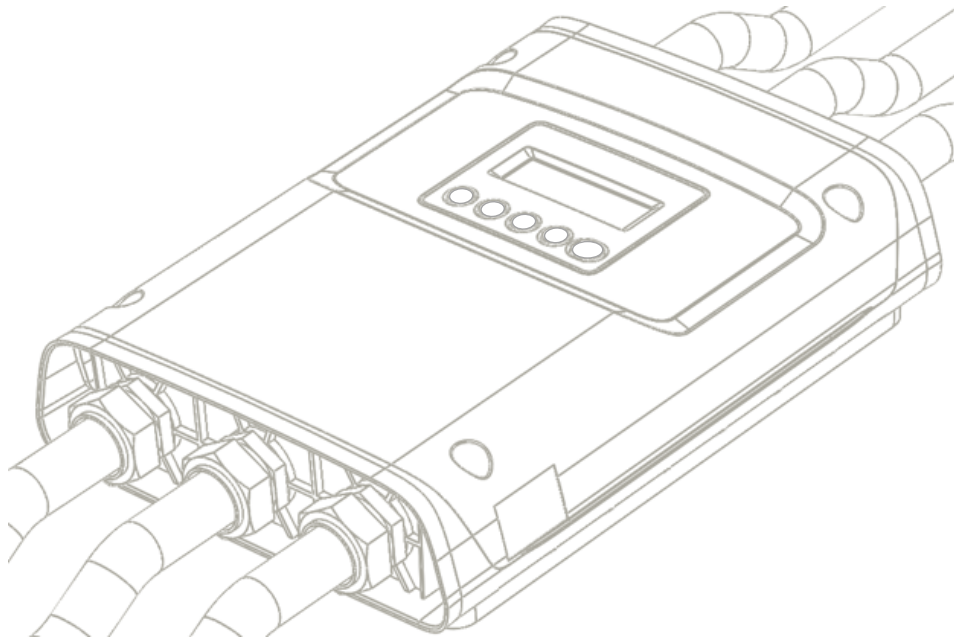

and

ViewPoint™ HD Software



June 30, 2020

Operator's Guide: PowerScout™ HD Power Meters ©2020 DENT Instruments, Inc. All rights reserved.

This manual may not be reproduced or distributed without written permission from DENT Instruments.

PowerScout™, ViewPoint™, TouchSāf™, and PhaseChek™ are trademarks of DENT Instruments, Inc.

Windows®, Windows® 7, Windows® 8, and Windows® 10 are registered trademarks of Microsoft Corporation.

Mac® and macOS® are registered trademarks of Apple Inc.

DENT Instruments | 925 SW Emkay Drive | Bend, Oregon 97702 USA
Phone 541.388.4774 | Fax 541.385.9333 | www.DENTinstruments.com

TABLE OF CONTENTS

Table of Contents..... **iii**

Introduction..... **7**

 Unpacking the Unit 7

 PowerScout HD Anatomy 8

 PowerScout 12 HD..... 9

 PowerScout 3HD Available Configurations 10

 PowerScout HD Meter Safety Summary and Specifications..... 11

 Symbols on Equipment 11

 Symbols in Documentation..... 11

Meter SAFETY **13**

Planning For Field Installation **14**

 Project Manager Aspects 14

 Configuration & Data Viewing Options 14

 Information Access by Interface Type..... 15

 Meter Configuration Overview 16

 Meter Installation Overview 16

 Verification & Communication Overview 17

 RTU Programming and Scripting Overview..... 17

Meter Configuration - Details **18**

 Install the ViewPoint HD Software..... 18

 TYPICAL INSTALLATION 18

 CUSTOM INSTALLATION 19

 INSTALLATION TROUBLESHOOTING 19

 UNINSTALLATION PROCEDURE 20

 Connection & Configuration Options Using ViewPoint HD 20

 USB Connection (Power & Communications) 21

 Ethernet Network Connections..... 22

 DYNAMIC HOST CONFIGURATION PROTOCOL (DHCP):..... 22

 DIRECT:..... 22

 LCD User Interface 22

 Meters without an LCD User Interface 23

 Network Scan 24

 Launch Configurator 24

 ViewPoint HD Software Overview 25

 ViewPoint HD Documentation 26

 ViewPoint HD Documentation—Instructional Videos 27

 Configuring Electrical Components Using ViewPoint HD..... 28

 Configuring Communications Using ViewPoint HD..... 29

 Configuring Alarms in ViewPoint HD..... 30

Table of Contents

Setting the Real Time Clock	32
Real Time Clock Power Source.....	32
Retrieving Interval Data.....	33
Updating Firmware.....	34
PSHD Web App Overview	36
Connect to Web App using Ethernet.....	36
Connect to Web App using USB	36
Authentication.....	36
macOS Users	37
Meter Installation - Details.....	38
Meter Mounting Configurations.....	38
Installation Sequence for Wall Mount Enclosure Models.....	39
Connecting Voltage	41
Installation Sequence for PS3HD-R-D-N.....	42
Connecting Voltage	43
Wiring the PSHD Meter in a 3-wire, Split ϕ Service Panel.....	44
Wiring the PSHD Meter in a 4-wire, 3 ϕ Service Panel.....	45
Wiring the PSHD Meter in a Single-Phase Application	46
Current Transformer Basics	47
Wiring the CTs to Multi Circuit PSHD Meters	48
Wiring CTs to PS3HD Meters	49
Communication & Verification - Details.....	51
Physical Connections on an RS-485 Multidrop Network	51
Communication Verification	52
ViewPoint HD / PSHD Web App	53
Physical Interface Verification	53
Serial Setup Verification	53
LAN Ethernet Network Verification.....	53
DHCP	54
STATIC IP.....	54
Protocol Verification	54
Modbus Settings	54
Modbus RTU Settings	54
Modbus TCP Settings.....	55
BACnet Settings.....	55
BACnet MSTP.....	55
BACnet IP.....	55
Pulse Outputs (Discontinued).....	55
Pulse Inputs – PS12HD/PS24HD/PS48HD Only.....	55
Alarm Output	56
12 Volt Auxiliary Power.....	56

Table of Contents

Access Restriction Limitations	58
Security PIN Protection	58
Using the Permission Registers	58
Read Only Permission Register.....	59
Read/Write Permission Register	59
Reading PINs Over Modbus.....	59
ViewPoint HD – Unrestricted Access.....	59
Verification of Installation	60
Installation Phase Verification.....	60
Phase Checking By Phasor Plot.....	61
CT Orientation Check	62
Power Factor Convention	63
Total Harmonic Distortion	63
Pre-Processing Aids.....	64
Snap Thresholds	64
Multipliers	64
CT Phase Shifts	64
Demand	64
RTU Programming and Scripting - Details	65
Register Organization.....	65
Element vs System Scope	65
Physical Implementation on PS48HD Meters	66
Configuring Element and Channel Register for Service Types	67
Configuring System Registers	69
Modbus Protocol Commands	69
Floating Point Registry Entry.....	73
BACnet	77
BACnet Segmentation	77
BACnet Structured View.....	77
Appendix A—PSHD LCD USER INTERFACE Menu Navigation.....	79
About Meter (Multi Circuit PSHD Meters)	79
Menu Navigation (Multi Circuit PSHD Meters)	80
Communication Navigation (Multi Circuit PSHD Meters)	81
Navigation (PS3HD Meters).....	82
Appendix B—Enclosure Dimensions	83
Appendix C—Mounting Templates	85
Enclosure Internal Mounting Hole Locations (Not to Scale).....	85
Sheet Metal Plate Mounting Hole Locations (PS12HD/PS24HD/PS48HD only)	86
Appendix D: CT Phase Shifts	87
Appendix E: READ ME: ViewPoint HD Installation.....	88

Table of Contents

NEW INSTALLATIONS: For Users Where No Prior Version of ViewPoint HD Has Been Installed.....	88
SOFTWARE UPDATE: For Users with ViewPoint HD Software Already Installed	89
CUSTOM INSTALLATION: For Users Who Cannot Use the BATCH File	90
TROUBLESHOOTING.....	92
Appendix F—PSHD Technical Specifications.....	93

INTRODUCTION

There are four meters in the PowerScout HD Series: the PowerScout 3 HD (PS3HD), the PowerScout 12 HD (PS12HD), the PowerScout 24 HD (PS24HD), and the PowerScout 48 HD (PS48HD). These meters monitor the voltage, current, power, energy, and many other electrical parameters on single and three-phase electrical systems. A PSHD meter uses direct connections to each phase of the voltage and current transformers to monitor each phase of the current. Information on energy use, demand, power factor, line frequency, and more are derived from these voltage and current inputs.

The PSHD meter is not meant to be a standalone energy recorder; rather, it is connected as a slave device to a data logger, Remote Terminal Unit (RTU), or Building Management host network. The PSHD meter communication interfaces include Ethernet (LAN) or RS-485 serial. BACnet MS/TP and Modbus RTU are the two communication protocols that operate over an RS-485 serial network and BACnet IP and Modbus TCP are supported over Ethernet. A USB port is also provided as the preferred connection for on-site configuration and can be run concurrently with an RTU.

Unpacking the Unit

The PSHD can be ordered with optional product features which are identifiable on the part number label.

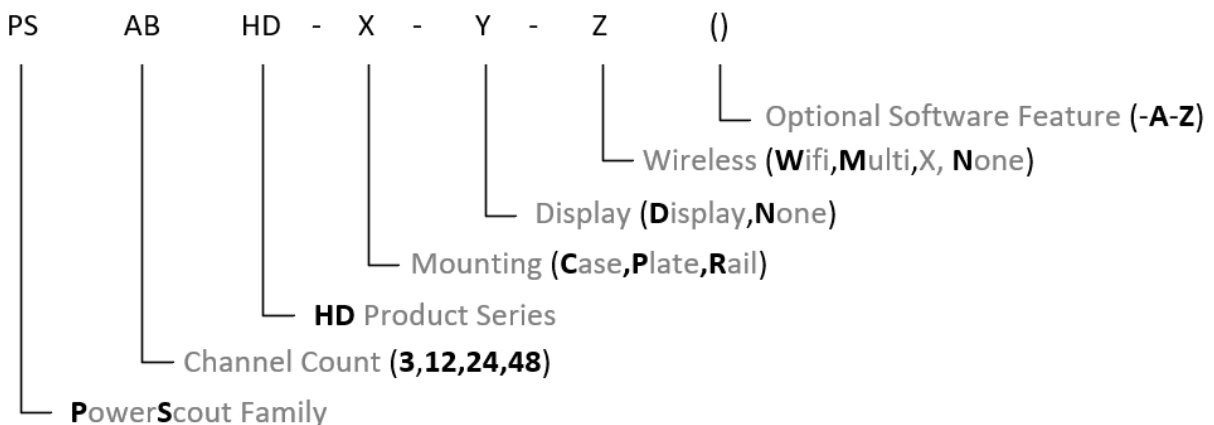

PowerScout HD Part Numbering Scheme

Each PSHD meter shipment also includes the following items:

- Meter with Options Installed – Serial Number, MAC ID, and FCC ID indicated on side label.
- Pluggable Connectors
 - PS48HD (2 voltage, 50 three-position terminals, 3 two-position terminals)
 - PS24HD (2 voltage, 26 three-position terminals, 2 two-position terminals)
 - PS12HD (1 voltage, 14 three-position terminals, 5 two-position terminals)
 - PS3HD (1 voltage, 4 three-position, 1 two-position terminals)

- USB thumb drive containing ViewPoint HD Software, Register List, Manual, Tutorial Videos
- Certificate of Calibration (COC)
- USB Cable (cable type dependent on meter choice)
 - USB A to B Cable (PS12/PS24/PS48; one per order)
 - USB A to C Cable (PS3HD; one per order)

PowerScout HD Anatomy

All user connections are made on the circuit board. Connectors are identified by function and include polarity markers.

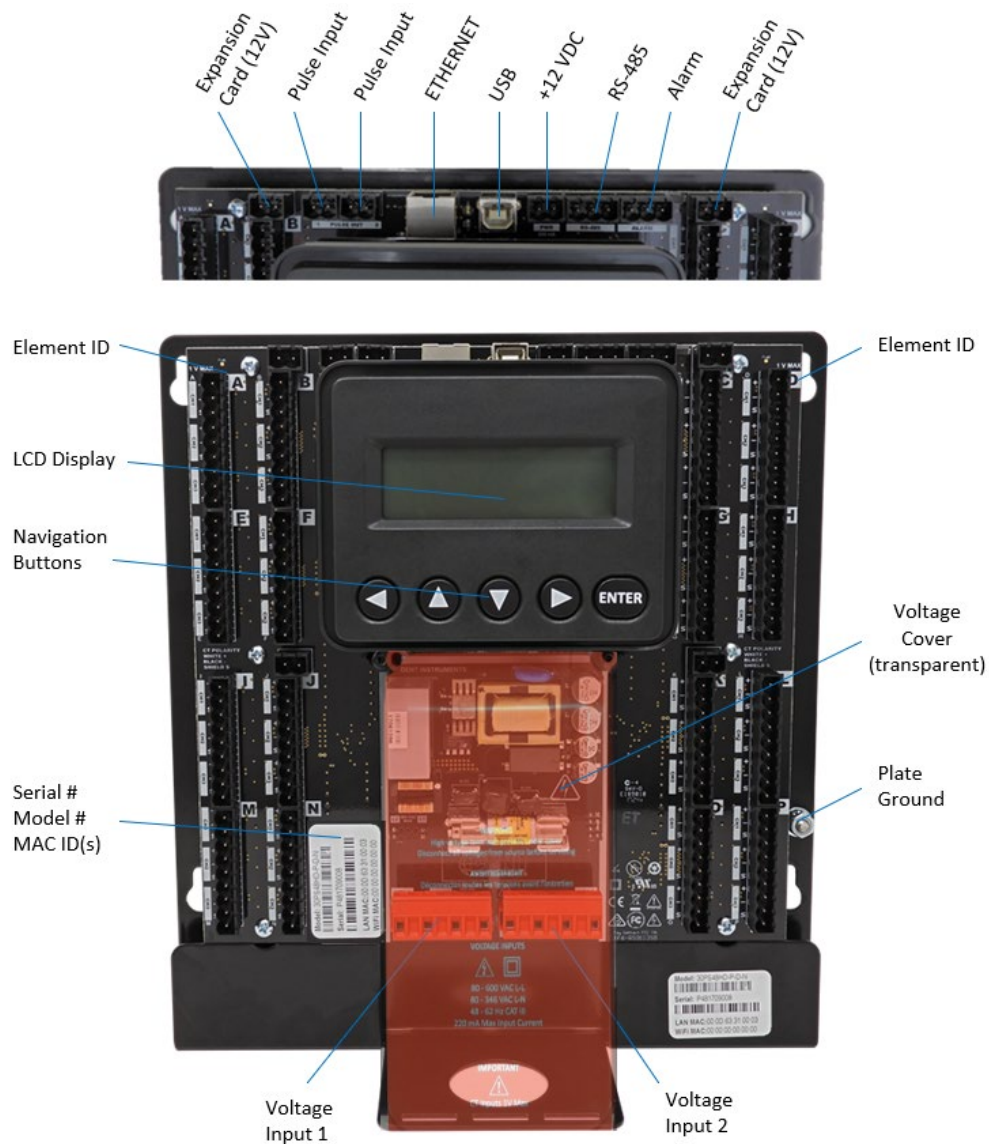

PS24HD/PS48HD (mounting plate version shown)

POWERSCOUT 12 HD

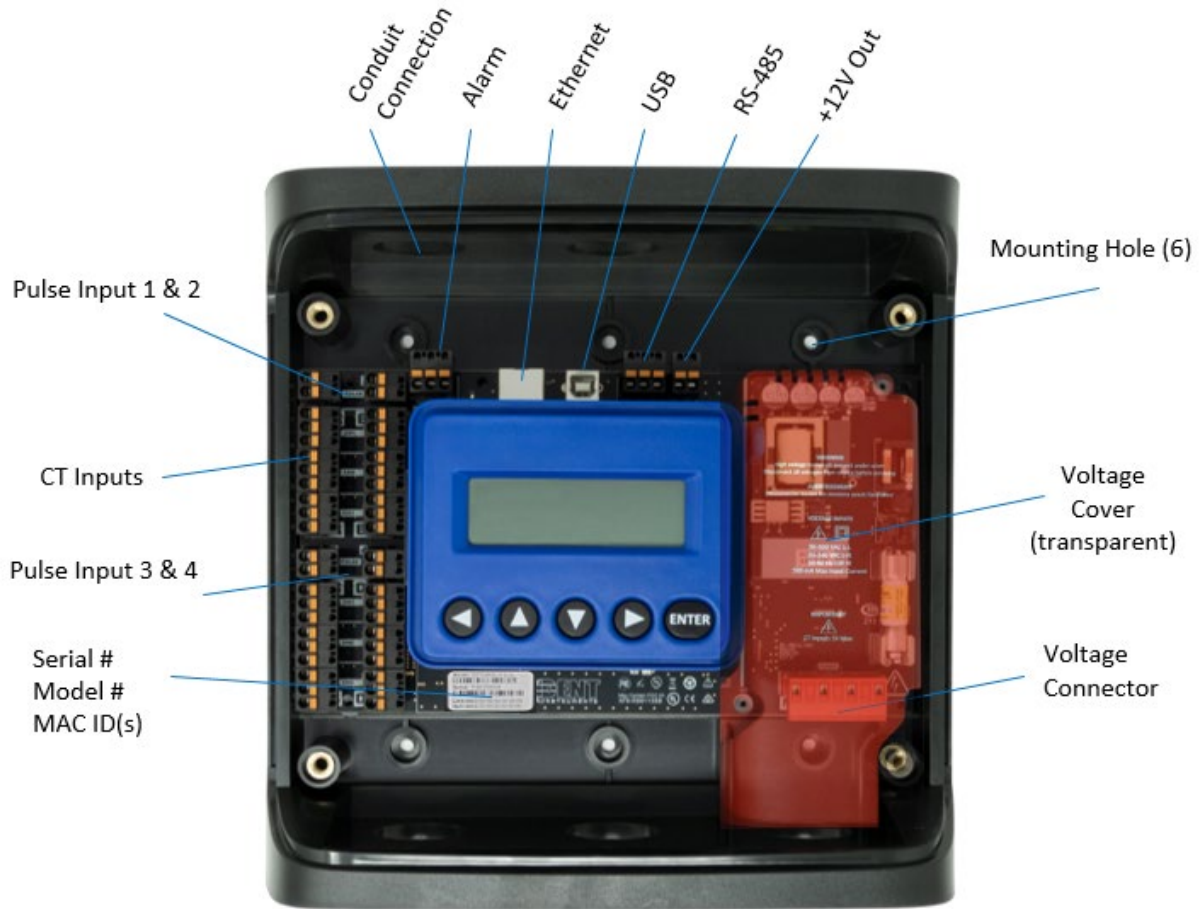

PS12HD (Enclosure with cover removed)

POWERSCOUT 3HD AVAILABLE CONFIGURATIONS

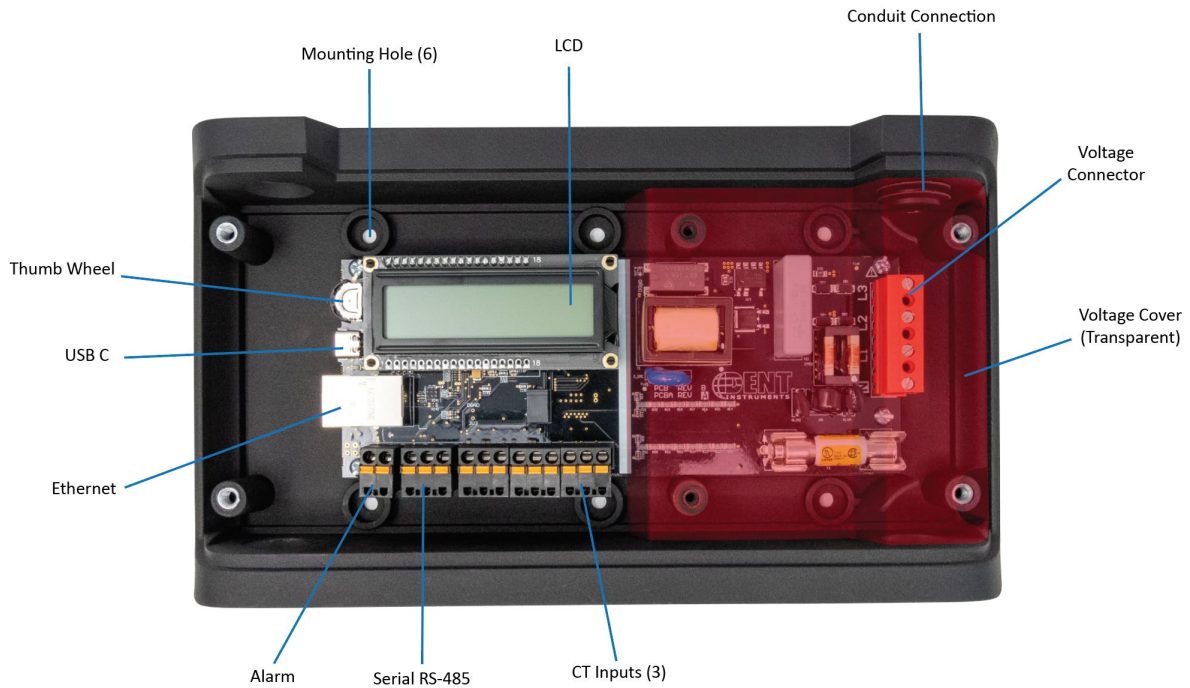

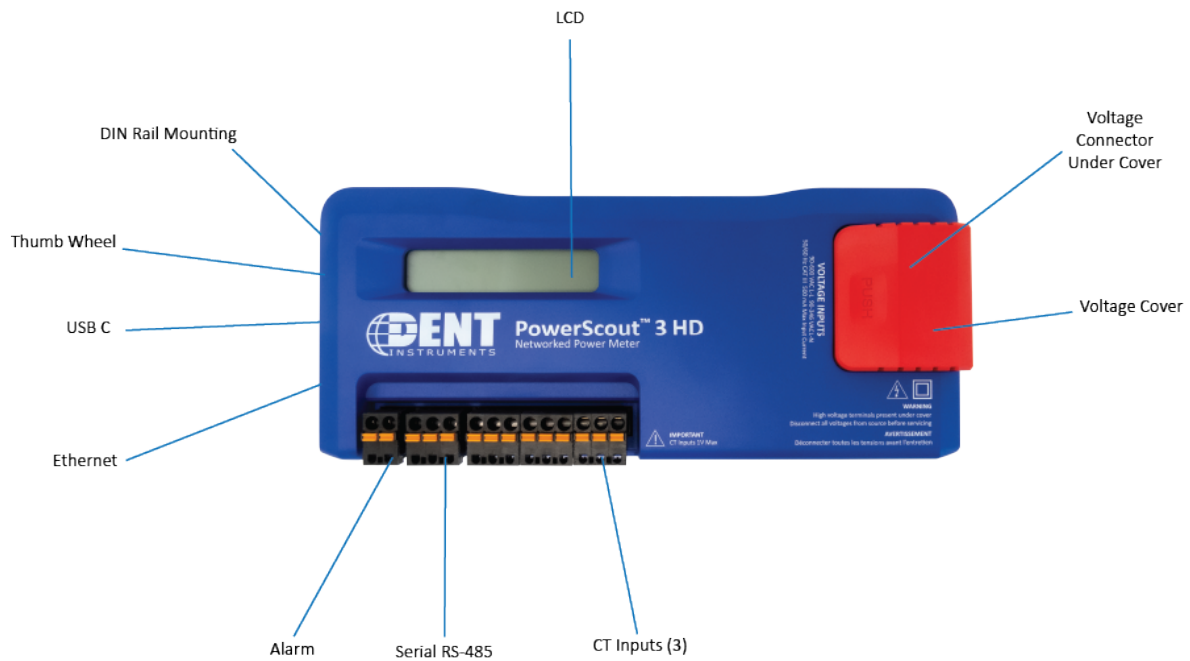

PS3HD Wall Mount Option (Enclosure with Cover Removed)



PS3HD DIN Rail Mount Option

PowerScout HD Meter Safety Summary and Specifications

<p>This general safety information is to be used by both the Logger operator and servicing personnel. DENT Instruments, Inc. assumes no liability for user's failure to comply with these safety guidelines.</p>	 <p>PS12HD-P-y-z PS48HD-P-y-z</p>  <p>LISTED E186827 PS12HD-C-y-z PS48HD-C-y-z PS3HD-C-D-N PS3HD-R-D-N</p>	<p>The PSHD Family conform to the following:</p>  <p>PowerScout HD Series: Conforms to UL Std 61010-1, 3rd Edition Certified to CSA Std C22.2 No. 61010-1, 3rd Edition</p>
<p>The following PowerScout HD devices need to be installed in a user-supplied UL Listed or Recognized enclosure in order to comply with NEC and local electrical codes: PS12HD-P-y-z, PS24HD-P-y-z, PS48HD-P-y-z, and PS3HD-R-D-N (,)(-A-Z)</p>		
<p>The PowerScout HD is an Over-Voltage Category III device. Use approved protection when operating the device.</p>		
<p>CAUTION: THIS METER MAY CONTAIN LIFE THREATENING VOLTAGES. QUALIFIED PERSONNEL MUST DISCONNECT ALL HIGH VOLTAGE WIRING BEFORE SERVICING THE METER WITH THE HIGH VOLTAGE TOUCH SAFE (TouchSaf™) COVER REMOVED.</p>		

Symbols on Equipment



Denotes caution. See manual for a description of the meanings.



DENOTES HIGH VOLTAGE. RISK OF ELECTRICAL SHOCK. LIFE THREATENING VOLTAGES MAY BE PRESENT. QUALIFIED PERSONNEL ONLY.



Equipment protected throughout by double insulation or reinforced insulation.

Symbols in Documentation



Contains additional information pertinent to current subject



DO NOT EXCEED 346V Line to Neutral or 600 volts Line to Line. This meter is equipped to monitor loads up to 346V L-N. Exceeding this voltage will cause damage to the meter and danger to the user. Always use a Potential Transformer (PT) for voltages in excess of 346V L-N or 600 volts line to line. The PowerScout HD is a 600 Volt Over Voltage Category III device.

MAINTENANCE

There is no required maintenance with the **PowerScout HD**. Abide by the following items:

Cleaning: No cleaning agents, including water, shall be used on the **PowerScout HD**.

No accessories are approved for use with the PowerScout HD meter other than those specified in the DENT Instruments product literature and price sheets.

If the meter appears damaged or defective, first disconnect all power to the meter. Then call or email technical support for assistance.

DENT Instruments, Inc.

Bend, Oregon USA

Phone: 541.388.4774

www.DENTinstruments.com

Email: support@DENTinstruments.com

METER SAFETY



Building Service Safety Requirements (Load Center, etc.)

- Equipment intended for use with field-installed **current transformers that could be installed in panel boards or switchgears** shall observe the following:
 - Always open or disconnect circuit from power-distribution system (or service) of building before installing or servicing current transformers.
 - A circuit breaker used as a disconnect must meet the requirements of IEC 60947-1 and IEC 60947-3 (Clause 6.11.4.2).
 - Current transformers may not be installed in equipment where they exceed 75 percent of the wiring space of any cross-sectional area within the equipment.
 - Current transformers may not be installed in an area where they block ventilation openings.
 - Current transformers may not be installed in an area of breaker arc venting.
 - Not suitable for Class 2 wiring method nor intended for connection to Class 2 equipment.
 - Secure current transformer and route conductors so that they do not directly contact live terminals or bus.
 - CTs shall be listed to UL2808 where applicable.



Meter Installation Safety Requirements

- PSHD meters must be installed in accordance with local electrical codes.
- Use copper conductors only.
- Connection to the mains terminals shall be made with 14 AWG minimum wire gauge.
- External secondary inputs and outputs should be connected to devices meeting the requirements of IEC 60950.
- The following additional requirements apply for Recognized board versions of the PSHD meter
 - For use only with Listed Energy-Monitoring Current Transformers
 - Associated leads of the current transformers shall be maintained within the same overall enclosure.
 - Unless the current transformers and its leads have been evaluated for REINFORCED INSULATION, the leads must be segregated or insulated from different circuits.
 - The current transformers are intended for installation within the same enclosure as the equipment. These may not be installed within switchgears and panel boards or similar.

PLANNING FOR FIELD INSTALLATION

Project Manager Aspects

Meter installation often includes coordination between individuals or groups of people with different responsibilities. Spend a few minutes considering who will be executing each portion of the installation and what tools are needed at each stage. Things to consider include determining how to communicate with the meter, setting address configuration, installing ViewPoint HD, access to PIN numbers, etc. The more tasks completed before installation the fewer tasks will be needed in the field, where most mistakes happen. The following section gives an overview of typical process activities followed by details in the next section.

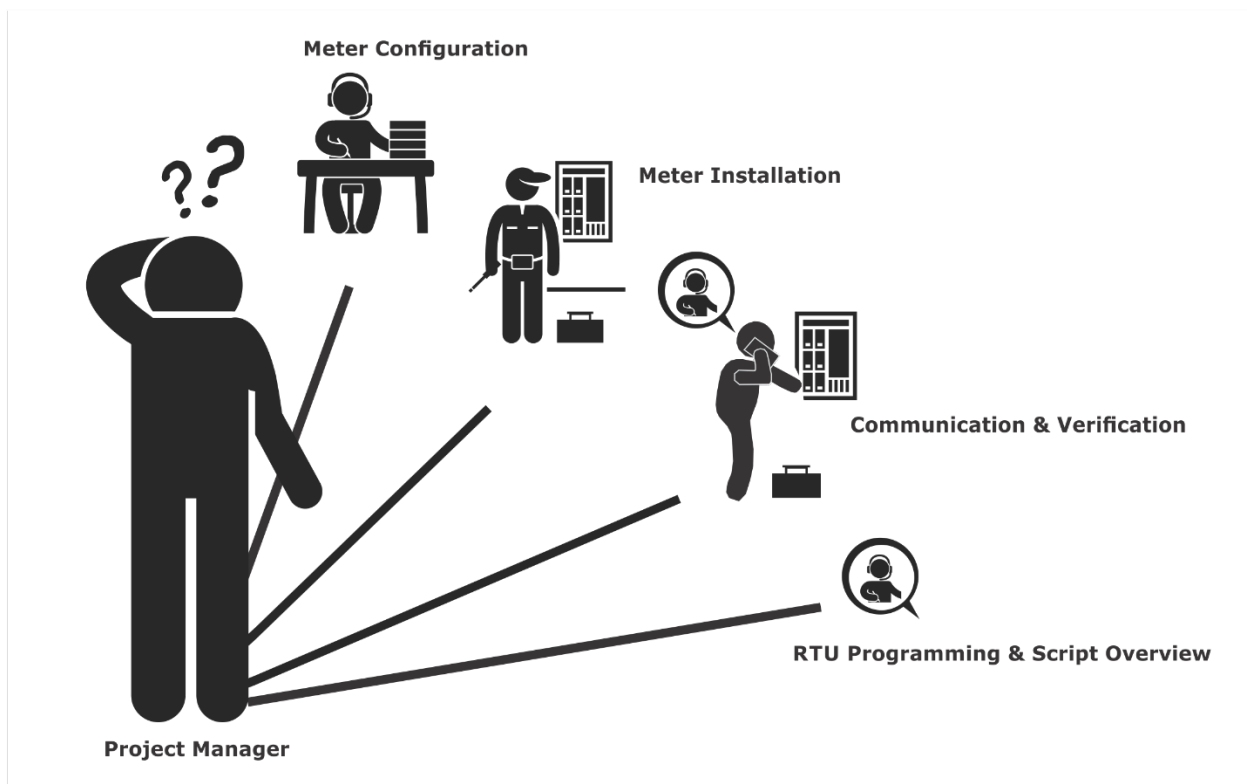

CONFIGURATION & DATA VIEWING OPTIONS

The PowerScout HD meter has three methods for configuration and data viewing. The most powerful interface is ViewPoint HD, a Microsoft Windows application that runs on PCs or Tablets. ViewPoint HD is encouraged for complex installations and is required for configuring advanced functions, like alarms. The second interface is the PSHD Web App and is intended for smart phones or tablets that can connect to the meter over USB or Ethernet. The third interface is the optional LCD user interface and is intended for intermittent end-user observation and is restricted in capability. The RTU can also be used for configuration if communication settings are already established. The feature set of each interface is summarized next.

INFORMATION ACCESS BY INTERFACE TYPE

DENT Interface Options				User
Device	PC or Laptop Running ViewPoint HD	Smart Device or Tablet via PSHD Web App	LCD User Interface on Meter (if equipped)	RTU (Host System) Modbus /BACnet
When Used	Meter Setup Field Visit	Field Visit	End User	Building System
Real Time Values	All Meter Parameters Waveform Capture Harmonic Analysis All Element View Phasor Plot Alarms	All Meter Parameters Single Element View	Voltage Current VA VAR kWh Single Element View	All Meter Parameters
Configuration	Entire Meter Visual Guides Copy / Paste	Entire Meter Sans Alarms Text Based	Communications Only	Entire Meter Register Based
Security PINs Enforced	Factory Support – Level 3	Read Only – Level 1* Read / Write – Level 2*	Read Only – Level 1* Read / Write Level 2* (limited to communication)	Factory Support – Level 3

* If PINs are configured

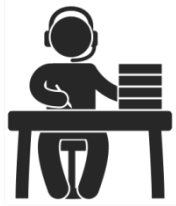

Meter Configuration Overview

- Work performed ahead of the installation saves time in the field and results in fewer mistakes!

Tools	Typical Work
<ul style="list-style-type: none"> • Desktop or Laptop PC • Appropriate USB Cable (preferred) or Ethernet & USB wall charger (> 500 mA) • Thumb Drive (ViewPoint HD Installer) or access to https://www.dentstruments.com/software-downloads • Electrical Schematics of project 	<ul style="list-style-type: none"> • Installation of ViewPoint HD Software • Connect USB/Ethernet cable from PC to meter • Establish communication with meter • Firmware update (if desired) • Configure software for anticipated meter setup • Field wiring documentation • Set alarms • Set security PINs



Meter Installation Overview

- Performed by licensed electrician.

Tools	Typical Work
<ul style="list-style-type: none"> • Mounting hardware (user supplied) • Wiring & supplies, labels, wire ties • Tablet, Smart Device, or Laptop PC • Multi Meter, Current Clamp • Camera 	<ul style="list-style-type: none"> • Mechanical mounting • Electrical installation • Install voltage cover • Apply power to meter • Confirm basic operation of meter



Verification & Communication Overview

- Can be modified with power applied to the meter.

Tools	Typical Work
<ul style="list-style-type: none"> • Tablet, Smart Device (Web Page Based), or Laptop PC (ViewPoint HD Software) • On site troubleshooting • Multi Meter, Current Clamp • Camera 	<ul style="list-style-type: none"> • Locate the power meter • Confirm RTU device • Add wire terminations (if required) • Confirm meter communication settings • Meter health metrics (check for setup errors) • Analytics (ViewPoint HD) • Correct instrumentation • Set alarms • Set security PINs • Checklist



RTU Programming and Scripting Overview

Tools	Typical Work
<ul style="list-style-type: none"> • Laptop PC (Remote Access to RTU) • Remote troubleshooting • Register List 	<ul style="list-style-type: none"> • Confirm meter communication settings • Confirm communication protocols • Exercise remote connectivity • Run configuration scripting • Set alarms • Set security PINs • Confirm data integrity

METER CONFIGURATION - DETAILS



This section is written to support setting up the PSHD in an office environment and configuring the power meter for a pre-determined configuration. In many cases, the setup is standardized for an organization or project. In other cases, the setup can be documented and emailed to an installer. The setup can also be performed on-site and reflect “as-built” configurations.



The PSHD meter cannot be configured using ViewPoint HD over a serial port. RS-485 serial network configurations must be pre-configured or use Modbus / BACnet hosts.



This section describes the use of the ViewPoint HD Windows Application. If this interface cannot be used, refer to the section on using the simplified **PSHD Web App** interface. The web browser can be accessed from the USB port to support macOS users.

Install the ViewPoint HD Software

The following directions assume that this is a “fresh” installation of ViewPoint HD software. If you are upgrading ViewPoint HD from a previous version, follow the **Uninstallation Procedure** at the end of this section prior to installing new software. Instructions can also be found in the UPGRADE INSTALLATION READ ME.txt file accompanying the ViewPoint HD installer.

Insert the ViewPoint HD thumb drive into the computer or download from



<https://www.dentstruments.com/software-downloads>

Locate the ViewPoint HD Installer folder and copy it to your desktop. Running the installer directly from the USB drive or from a server location may lead to the installation being unsuccessful.

 ViewPoint HD Installer 4/9/2018 11:50 AM File folder

TYPICAL INSTALLATION

Double-click the “**RunMe to Install ViewPoint HD.bat**” batch file to install ViewPoint and its support files in Windows default locations. This option works for most users.

Name	Date modified	Type	Size
 Install Files	3/3/2020 8:00 AM	File folder	
 Run Me to Install ViewPoint HD.bat	7/12/2019 10:23 AM	Windows Batch File	1 KB
 UPGRADE INSTALLATION READ ME.txt	2/22/2019 11:37 AM	Text Document	1 KB

CUSTOM INSTALLATION

For users who want to specify the location of the ViewPoint HD software and support files, double-click the folder “Install Files” and run setup.exe. This will prompt the user for additional details. Selecting the run setup.exe instead of the batch file also requires users to run a separate installer for the LabView RunTime engine located within the LVRTE folder. This second step is handled automatically in the batch file.

Name	Date modified	Type	Size	8 items	
bin	4/20/2018 8:54 AM	File folder			
license	4/20/2018 8:54 AM	File folder			
Local	4/20/2018 8:54 AM	File folder			
LVRTE	4/20/2018 8:54 AM	File folder			
supportfiles	4/20/2018 8:54 AM	File folder			
nidist.id	4/17/2018 10:51 AM	ID File			
setup.exe	4/17/2018 10:51 AM	Application	1,40		
setup.ini	4/17/2018 10:51 AM	Configuration sett...			

Name	Date modified	Type	Size	
Bin	9/18/2018 3:43 PM	File folder		
Licenses	9/18/2018 3:43 PM	File folder		
Products	9/18/2018 3:43 PM	File folder		
nidist.id	11/2/2017 1:19 AM	ID File		1 KB
patents.txt	8/15/2017 2:51 AM	Text Document		24 KB
setup.exe	11/2/2017 1:01 AM	Application		1,410 KB
setup.ini	11/2/2017 1:19 AM	Configuration sett...		28 KB

INSTALLATION TROUBLESHOOTING

Successful installation of ViewPoint HD may be prevented by settings specific to your PC for the following reasons:

- 1) Anti-virus protection software may interfere with the installation of ViewPoint HD. If the installation does not complete for this reason, try temporarily disabling the virus protection software on your PC and re-attempt the installation.
- 2) Administrative Access. In some cases, user privilege settings may disallow the installation of new applications. This may require logging in as an administrator.

UNINSTALLATION PROCEDURE

If ViewPoint HD software had been previously installed on a computer, installation of a new version of software “over the top” of an existing version of ViewPoint HD may not replace all the support files required to run the software properly. Therefore, it is recommended that you uninstall previous versions of ViewPoint HD prior to updating the software.

Uninstallation is a two-step process which involves 1) removing ViewPoint HD using Windows and 2) deleting the ViewPoint HD folder from your hard drive.

- 1) Open the Windows Uninstaller (Windows 10: Go to Add or Remove Programs under System Settings)
- 2) Search for ViewPoint HD or scroll down the program list to locate the program
- 3) Select the ViewPoint HD application and press the Uninstall button

After uninstallation is complete, perform the final steps to completely remove program’s support files from your hard drive:

- 1) Open Windows File Explorer and navigate to the Local Disk (typically C:)
- 2) Delete the folder titled “ViewPoint HD”

Once the program has been uninstalled and the support files have been removed, follow the Typical Installation instructions at the beginning of this section.

CONNECTION & CONFIGURATION OPTIONS USING VIEWPOINT HD

When the ViewPoint HD application is launched, it will prompt the user to select one of four connectivity options.

- Connect over USB cable
- Connect over Ethernet to a Predetermined IP address
- Scan Network for Meters
- Create Setup file only (no meter connected)

Note: The USB connection method is recommended for new users who have physical access to the meter and the appropriate USB cable (supplied). **Check out this option first!**

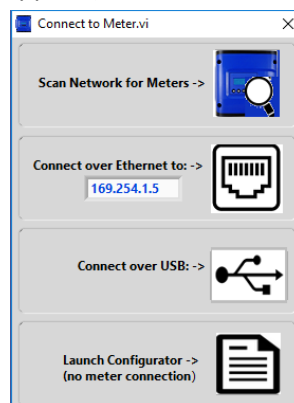

ViewPoint HD Connection Options

USB CONNECTION (POWER & COMMUNICATIONS)

- 1) Connect the PSHD meter to a USB port of your computer to provide both power and communications.
 - a. If equipped, the LCD user interface is the most visible indication of a running meter.
 - b. For meters without a display, a green flashing LED on the circuit board indicates that the PSHD meter has booted and is running.
 - c. PS12HD, PS24HD, and PS48HD meters draw 500mA from the USB port which may overload “out of spec” USB hosts. If the meter fails to power, or flickers when powering over USB, an alternate configuration for power must be used.
 - d. PS3HD meters draw 150mA from the USB port and should not require any additional external power when connected via USB.



A to B Cable

For use with PS12HD/PS24HD/PS48HD



A to C Cable

For use with PS3HD

Preferred Connection via USB Cable

- 2) Launch the ViewPoint HD application and press the “CONNECT OVER USB” button on the pop-up window.

The meter should now be communicating. The ViewPoint HD application offers visual guides and context help to facilitate meter configuration. Please read the ViewPoint HD overview section (below) or watch the tutorial videos for additional information on configuring the meter. By default, PSHD meters are configured for DNS Ethernet addressing. A very common configuration sequence is using USB to configure a meter for Ethernet communications at a static IP address and then switching from USB over to Ethernet to locate it. This is facilitated in ViewPoint HD by pressing the “Connect to Another Meter” icon located in the upper right-hand corner.

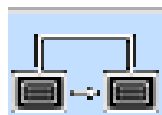

ETHERNET NETWORK CONNECTIONS

Configuring the PSHD over Ethernet requires that the meter be powered via a second connection, either USB or line power (L1-L2). The PSHD does not support Power Over Ethernet (POE). If the meter is already installed within the buildings electrical network, closing the AC breaker (or approved disconnect) will turn on the meter through the meter's internal power supply. In the rare case that a computer's USB port cannot provide enough current, an AC / USB charger or a USB battery can be used as a power source while using Ethernet for communications.



Both the “Network Scan” and “Connect Over Ethernet to IP ...” options require that a valid network connection (check IPv4 addresses and subnets) exists between the PSHD meter and configuration PC. This is a common startup issue!

DYNAMIC HOST CONFIGURATION PROTOCOL (DHCP):

PSHD meters are shipped in DHCP mode to prevent IP conflicts with other equipment. The meter is expecting to receive an IP address from a DHCP service provided by a router, Layer 3 switch, or a server providing DHCP service. Under this configuration, as long as the PSHD meter and the host PC are requesting an IP address from the same DHCP service provider, they will be able to communicate. Upon powering up, the PSHD meter will indicate the IP address on the LCD user interface (if equipped) or can be found using the Network Scan function.

DIRECT:

When a PC is directly connected to a PSHD meter via an ethernet cable, no DHCP service exists. This configuration can be made to work but requires changes to either the meter communication settings or the PC network configuration.

LCD User Interface

For units equipped with an LCD user interface, navigate to:

Communications → Ethernet Settings → DHCP → OFF

Change the IP address in the meter to match the subnet of your PC's IP address, making the meter IP unique, or note the current address on the meter and prepare to configure your PC's IP settings as shown on the next page.

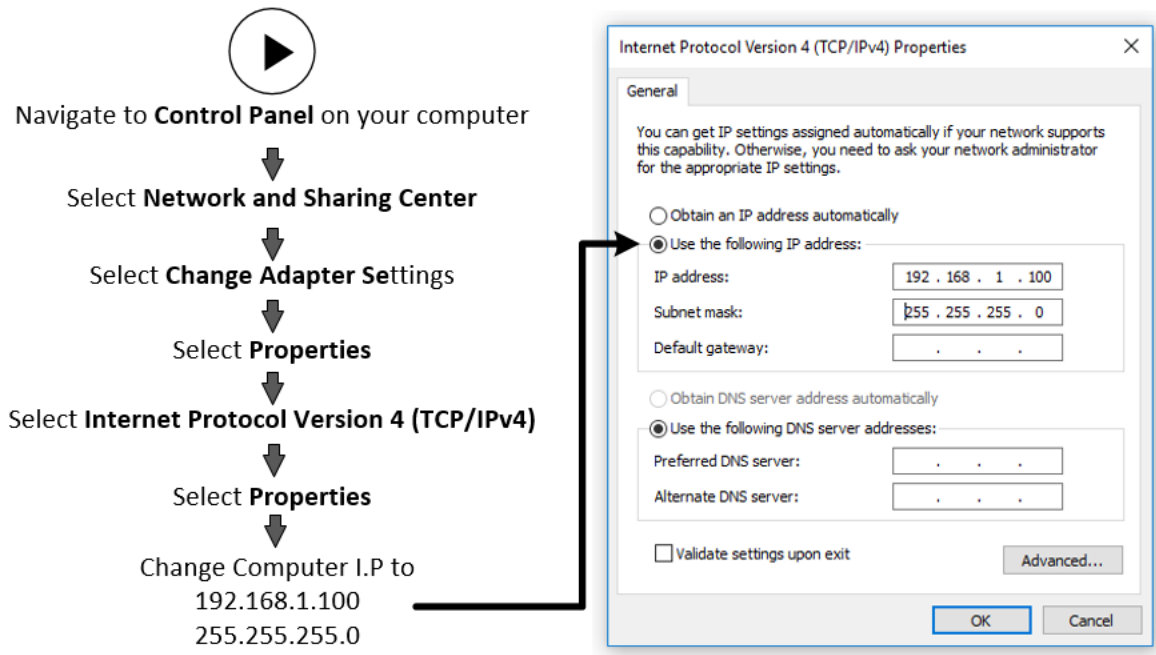

Once the PC and PSHD are set to communicate on the same IP subnet:

- 1) Launch the ViewPoint HD application and enter the IP address of the meter (shown as the factory default).
- 2) Press the “Connect over Ethernet to:” button on the pop-up window.

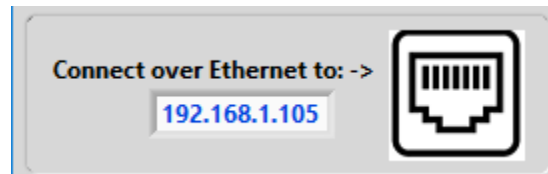

- 3) The meter should now be communicating. ViewPoint HD is an intuitive application; read the ViewPoint HD overview section (below) and/or watch the tutorial videos on the DENT website for additional information on configuring the meter.

Meters without an LCD User Interface

A PSHD meter without an LCD user interface has no way to communicate to the user its IP address and is only recommended if the meter has been previously set to a known static address. Setting the IP address must be done ahead of time using another interface such as ViewPoint HD over USB or via user-supplied applications over RS-485.

NETWORK SCAN

Network Scan is a feature for monitoring previously installed and configured PSHD meters over an Ethernet network. Network Scan will broadcast a User Datagram Protocol (UDP) discovery packet on the same network as the PC running the ViewPoint HD application. Normally this will be performed on a corporate network running DHCP. Any PowerScout HD meter that responds will be displayed in a table that includes the system description register, IP address, serial number, and communication configuration.

Meter	IP Address	Serial Number	MAC Address	Modbus Port	BACnet Port	Mode	Device ID	
68 SWB 454	10.75.75.68	P129999999	00:0D:63:32:99:99	502	47808	Modbus	527000	OK
AKL Headquarters	10.75.75.64	P481709013	00:0D:63:31:00:0C	502	47808	Modbus	527000	Cancel
PS12 JL Facility	10.75.75.14	P121812808	00:0D:63:32:88:87	502	47808	Modbus	527000	Rescan
PS48HD	10.75.75.151	P481810111	00:0D:63:31:00:01	502	47808	Modbus	527099	Test
								Setup

Highlight the desired meter and select OK, Test, or Setup. Note that the effectiveness of this technique is highly dependent on the configuration of the PC running ViewPoint HD (which may have more than one network card) and the network configuration. Rescans can be used to make multiple attempts to locate a particular meter on busy networks (UDP has no built-in retry provisions).

LAUNCH CONFIGURATOR

The final option in the ViewPoint HD Connect to Meter pop-up window is “Launch Configurator”. This option allows for the creation of a meter setup or alarm table for future use without connecting to a meter. After prompting the user for a meter model (shown below), ViewPoint HD launches under a mode with restricted functionality. This mode operates on files only.

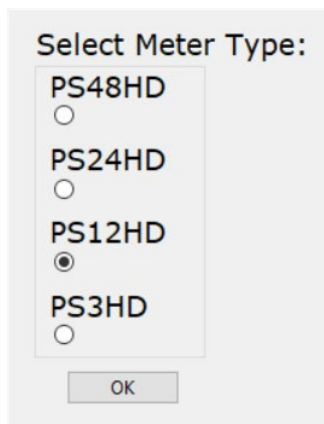

ViewPoint HD Software Overview



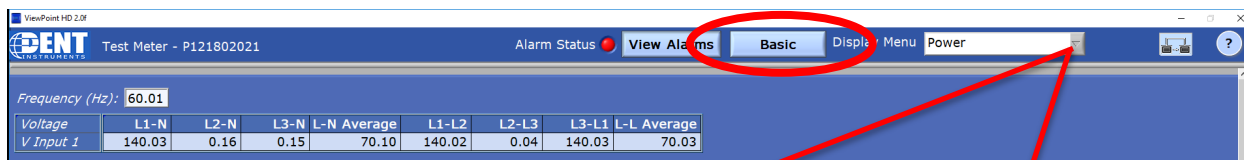

ViewPoint HD is a Windows application and is the most versatile software tool for configuring and verifying a PSHD meter. All functions and menus are accessed under the central drop-down list which has a content **filter** for viewing **basic** metering data or **extended** data that can be helpful in troubleshooting. The information displayed in the drop-down list for each filter setting is summarized below.



Display Data	
Basic	Extended
Monitor Power Energy Demand	Monitor Power Energy Demand Power Factor Waveform Capture Harmonics Phasor Plot
Setup Meter Setup Communication Setup Advanced About the Meter	Setup Meter Setup Communication Setup Alarms Advanced About the Meter

VIEWPOINT HD DOCUMENTATION

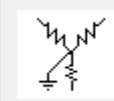
ViewPoint HD includes context help and other user-guiding features (shown below) to facilitate rapid and accurate configuration.

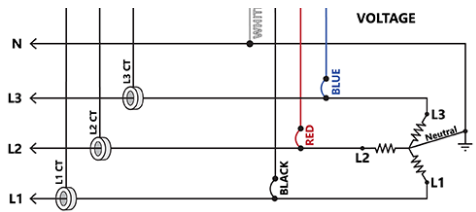
Help Aids					
<p style="text-align: center;">Information</p> <div style="text-align: center;">  </div> <div style="border: 1px solid black; padding: 5px; margin-top: 10px;"> <p>Frequency (Hz):</p> <p>DEFINITIONS: Frequency: Line frequency</p> <p>ModBus Address (16 bit) MSW,LSW BACNet Object REGISTER / OBJECT ADDRESSES</p> <table border="1"> <tr> <td>Description</td> <td>MSW, LSW</td> </tr> <tr> <td>Frequency</td> <td>1165, 1166</td> </tr> </table> </div>	Description	MSW, LSW	Frequency	1165, 1166	<p>This button toggles the Context Help pop-up window which displays the technical and register description of any screen object you hover over with the mouse. Example shown for Frequency.</p>
Description	MSW, LSW				
Frequency	1165, 1166				
<p style="text-align: center;">CT Type</p> <div style="text-align: center;">  </div> <div style="text-align: center; margin-top: 10px;">  </div>	<p>Current Transformer models are selected in the drop-down list and are identified by a combination of CT image and amperage range. The parameters for the selected CT are automatically populated. This information can be edited for custom use.</p>				
<p style="text-align: center;">Service Type</p> <div style="text-align: center;">  <p style="font-weight: bold; font-size: 1.2em;">4-Wire 3-Phase</p> </div>	<p>Select a service type from the drop-down list. A selection populates the fields with pre-configured service type information. User-selectable fields are shown in white. Greyed out fields indicate restrictions imposed by the meter.</p>				
<p style="text-align: center;">Wiring Diagrams</p> <div style="text-align: center; margin-bottom: 10px;">  </div> <div style="text-align: center;">  </div>	<p>Diagrams of different wiring configurations, such as illustrated here, are available directly within the software for quick reference.</p>				

VIEWPOINT HD DOCUMENTATION—INSTRUCTIONAL VIDEOS

Additional information about the capabilities of ViewPoint HD software are presented in short videos and can be found at <https://www.dentinstruments.com/resources/video> and on the provided thumb drive in the Videos folder.

Example Path to Videos:



Video Topic	Files @ ThumbDrive\Manual\VIDEOS	Description
PSHD Meter Setup	PSHD Meter Setup\ PSHD Meter Setup 8_18_2017.mp4	Identify the steps required for basic configuration of the power meter including selecting a voltage service and CT types.
Waveforms & THD	PSHD Waveform & THD Example\ Waveform THD Demo.mp4	Discover how to use the power meter as an oscilloscope to view electrical waveforms and identify harmonic distortion.
Phasor Plot	PSHD Phasor Plot\ Phasor Plot Demo.mp4	Discover how to use the electrical phasor plot to graphically confirm correct CT placement and orientation.
Alarms Demo	PSHD Alarms Demo\ Alarms-demo.mp4	Discover how to configure and manage event alarms for conditions such as over current or under voltage.
Setting up a PIN	PSHD PIN Demo\ PIN Demo.mp4	Discover how to set up a security PIN to protect information access to the meter's LCD user interface or web page.
Excel Register List Tips	Register List Demo\ Register List.mp4	Discover how to use filters in the MS Excel Register document to quickly locate registers or BACnet objects of interest.

CONFIGURING ELECTRICAL COMPONENTS USING VIEWPOINT HD

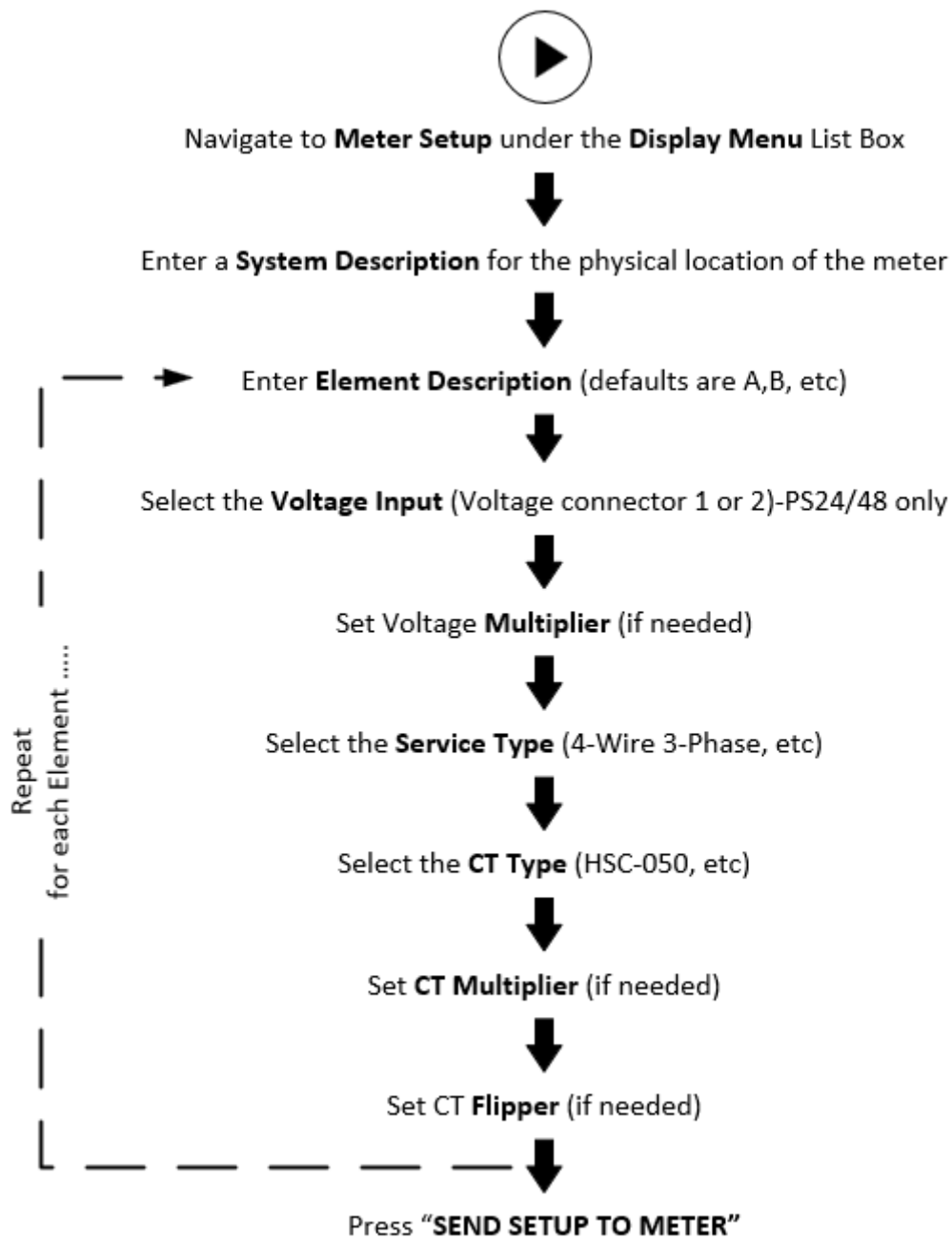

CONFIGURING COMMUNICATIONS USING VIEWPOINT HD

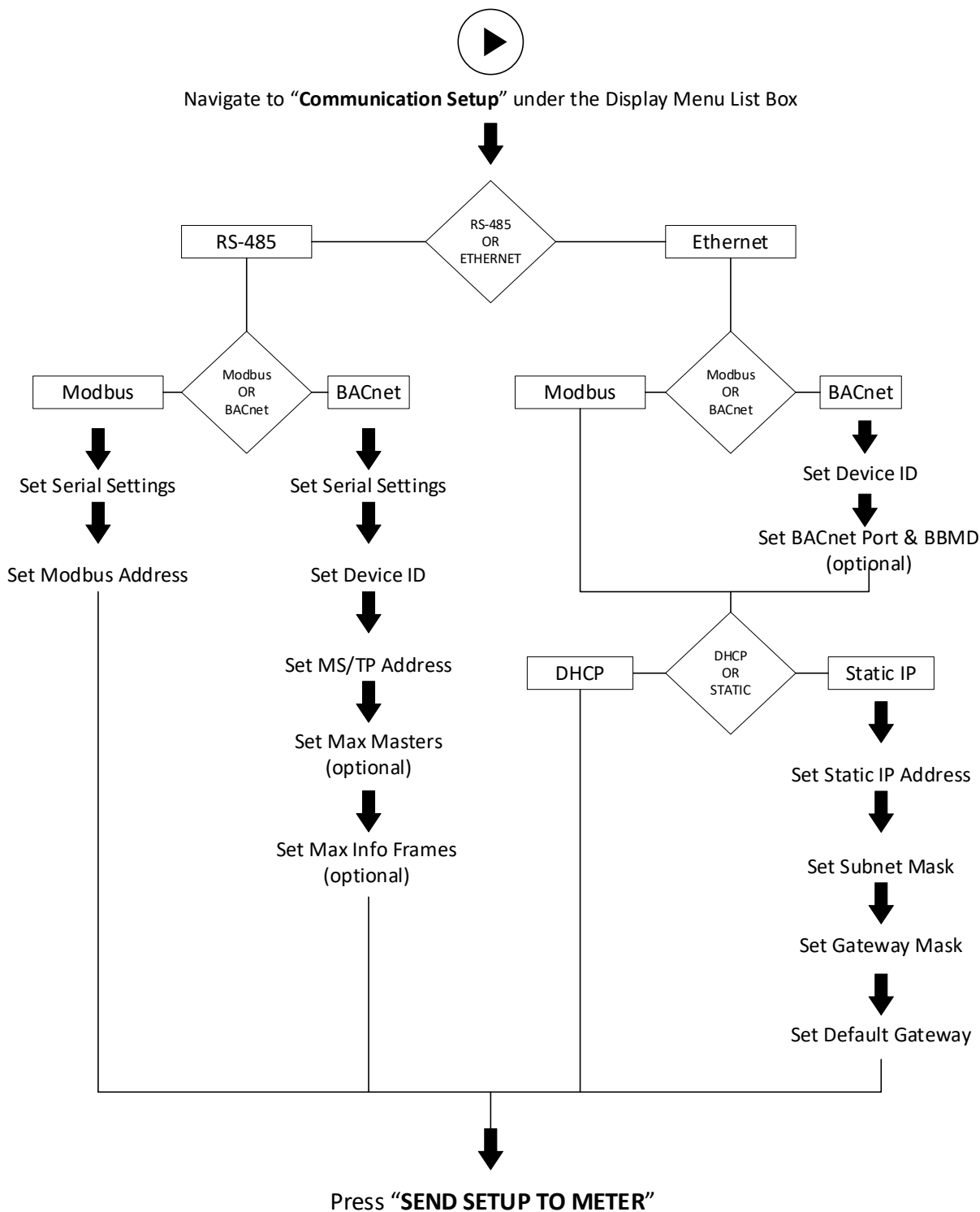

CONFIGURING ALARMS IN VIEWPOINT HD

All PSHD meters can set conditional alarms. Early PSHD meters had a wide variety of alarm types for voltages and currents and a complex configuration utility to set them. Our customer feedback has been that only the “Voltage Phase Loss” alarm has been widely utilized. In the spirit of simplification, the alarm response model has been reduced to “Under-voltage” detection only beginning with firmware version 2.50. The physical hardware has also been changed from a latching electromechanical relay to an isolated open collector transistor type. Details about interfacing with this circuit are covered in the section titled “Alarm Output” later in this manual.

Alarm settings are accessed using ViewPoint HD under the “ALARMS SETUP” drop down list using the “Extended” filter option in the title bar.

Integer Values can be entered for Voltage Input 1 (PS3HD and PS12HD meters) and Voltage Input 2 (PS24HD and PS48HD meters) for L-N and L-L voltage measurements. Alarms are activated by toggling the “Enable” button for each voltage reference independently and pressing the “Send to Meter” button.

An example of a 10% drop in a 480 VAC Delta System is shown below. Only Line to Line measurements are enabled.

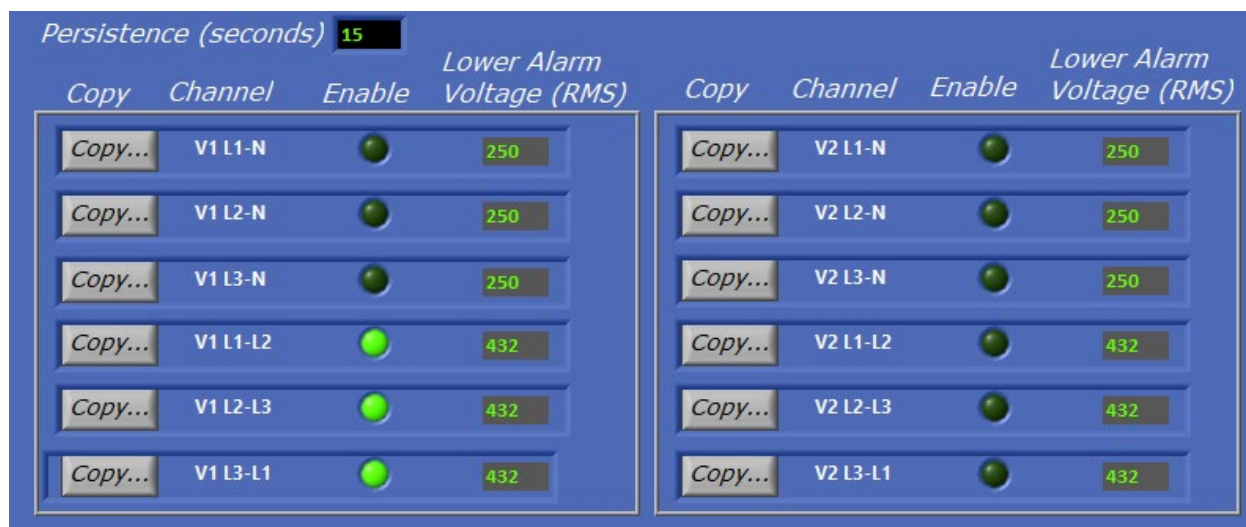

Lower Alarm Voltage values can be copied to other voltage references using the “Copy...” button, which brings up a dialog and allows the user to choose which references to copy. Note that the maximum value that can be entered into L-N voltage references is 350V and the maximum value that can be entered into L-L voltage references is 600V. Attempting to enter a value higher into these fields will result in the software setting each field to its maximum value.

The Alarm Persistence field is user-configurable and the time can be adjusted from 15-60 seconds. The alarm condition must be continually expressed for the persistence time to trigger the alarm. This behavior helps reduce false positives on momentary voltage changes or events that cause the meter to reboot such as changing communication settings.

A triggered alarm will cause the Alarm Status indicator at the top of ViewPoint HD to turn red. If an alarm is enabled but not triggered, the indicator will be bright green. If no alarms are enabled, the indicator remains dark.

Host systems are notified of an alarm via a hardware circuit (normally low) that can be wired to an interrupt input. Details about which alarm triggered are determined by reading the status registers under the alarm block 2450 – 2500.

Alarms no longer need to be “cleared” by the host. The alarm will be expressed whenever the condition exists and will clear itself if measured values exceed the trigger points. Alarm conditions are evaluated by the meter once per second.

SETTING THE REAL TIME CLOCK

The PSHD meter includes a Real Time Clock (RTC). The clock is used only to time stamp Interval Data in the log; it is not used for calculation within the meter. For users of the Interval Data Recording (IDR) function of the meter, it is helpful (but not strictly necessary) to set the real time clock so that data records can be uniquely identified. The time can be set using ViewPoint HD, under the Advanced Tab, by clicking on the clock icon in the bottom right corner of the clock/calendar area.

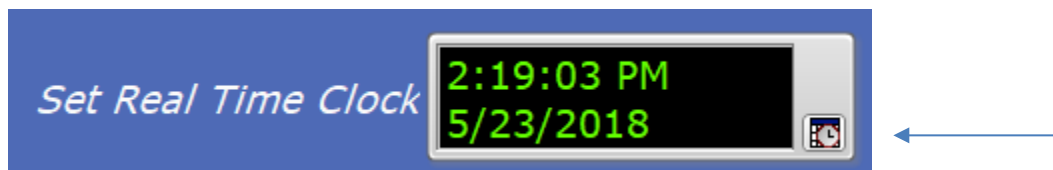

The clock icon launches the Calendar window and allows the user to set any desired date and time. “Set Time to Now” populates the sets the time and date to match the PC. Press the “OK” button to commit this time to the RTC chip onboard the meter.

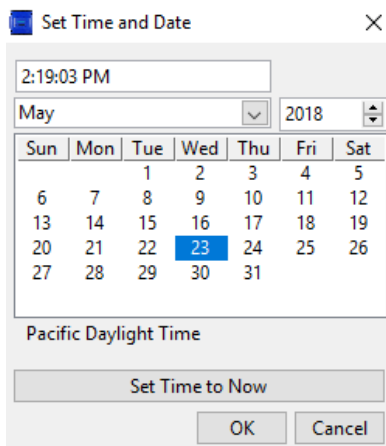

Real Time Clock Power Source

The RTC integrated circuit is a standalone low power circuit within the PSHD meter. Time is kept in the absence of a connected external power source (AC or USB power) by a super capacitor. The capacitor can keep the RTC running over normal power outages (days to weeks) but is not expected to keep time while the meter is being stored or shipped.



Users desiring to use the Interval Data Recording capability of the PSHD meter will want to have a procedure that ensures the Real Time Clock is set as part of the commissioning process.

RETRIEVING INTERVAL DATA

The PSHD meter maintains an internal log of the energy data (Net kWh) for each channel in the meter. This log is updated every 15 minutes and is always active. The meter stores 63 days' worth of 15-minute data in its memory. This data can be retrieved by users looking to restore gaps in data collection where RTUs may have been offline or communication has been interrupted. The Interval Data Recording (IDR) is assessed through ViewPoint HD in the Advanced menu.

Click the "Download" button.



By default, the name of the data file will include the Serial Number of the Meter and the System Description followed by "-Datalog" (see below).

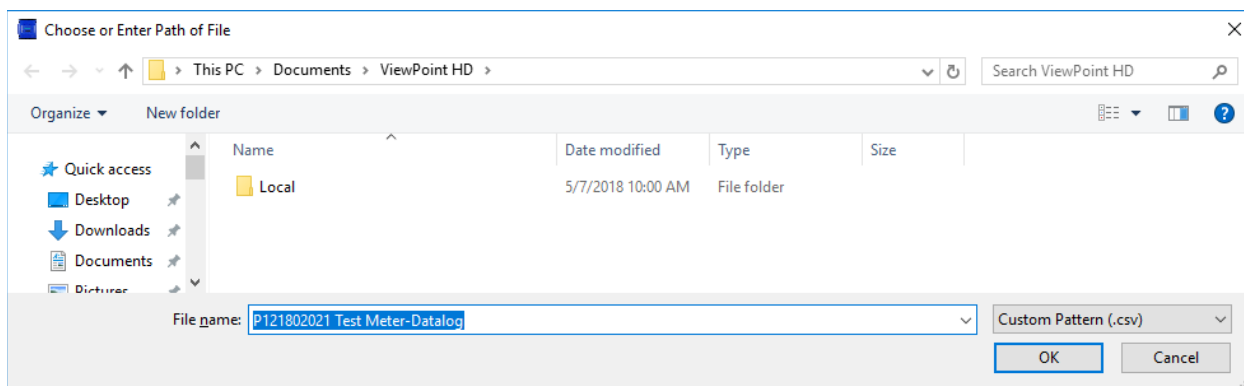

After pressing "OK," the entire data path will be displayed

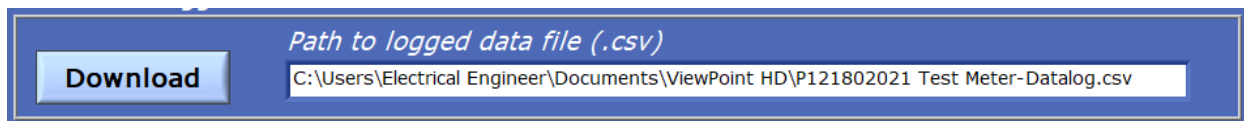

The data log is a Comma Separated Values (CSV) file that can be opened in Excel or another program. The data will be listed in chronological order according to an internal 32-bit sequence counter. The sequence counter can be used to merge separate files together, if necessary (example below).

Sequence Number	Time Stamp	A1 kWh	A2 kWh	A3 kWh	A System	B1 kWh ...
123456	5/15/2018 12:00	1.11E+5	2.22E+5	3.33E+5	6.66E+5	0
123457	5/15/2018 12:15	1.12E+5	2.23E+5	3.34E+5	6.69E+5	0

UPDATING FIRMWARE

PSHD meter firmware is updated approximately twice a year in response to minor bug correction or customer requested features. Documentation is expected to be downloaded and used together within a “Media Release” which includes firmware, ViewPoint HD Updates, register list updates, and manual updates. Mix and match operation of components between separate Media Releases is not recommended. The basic updating procedure is as follows:

- 1) Download the Latest Media Distribution (from the DENT website) and review the change log.
- 2) Un-install and Re-install ViewPoint HD software (ViewPoint HD uninstallation directions can be found in the *Meter Configuration* section of this guide.)
- 3) Locate the appropriate binary file within the Firmware folder of the Media Release (example below)

Name	Date modified	Type	Size
 HD12E-02-07.bin	8/22/2019 9:01 AM	BIN File	465 KB

- 4) Connect to the meter using ViewPointHD and locating the “Firmware Update” utility window on the Advanced tab.



- 5) Press the “File Finder”  and locate the model appropriate binary file (HD03,HD12 ...)

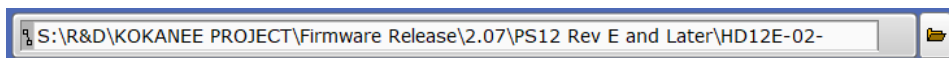

- 6) Press the “Upgrade” button and Acknowledge the warning

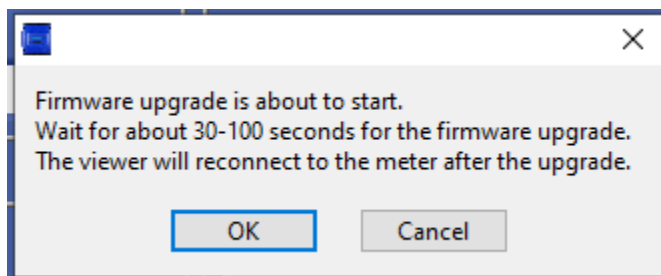

- 7) Observe the Progress of the File Transfer into Flash memory.

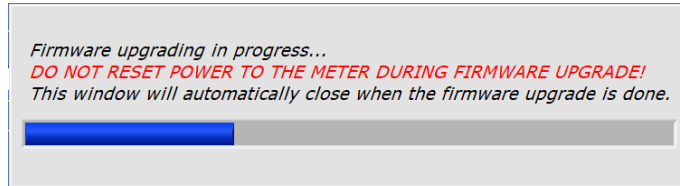

8) Acknowledge the upgrade

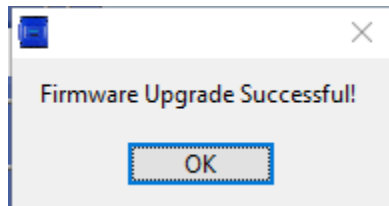

PSHD Web App Overview

The PSHD power meter hosts a Web Application that can be accessed by any device running a web browser. The PSHD Web App can be accessed by using the **USB or Ethernet port**.



macOS users can configure the meter using the PSHD Web App Interface by installing a driver which is included in the Media Distribution materials or on the DENT website.

CONNECT TO WEB APP USING ETHERNET

- 1) Discover the IP address of the meter by one of the following methods (a-c)
 - a. Navigate to About Meter on the LCD user interface.
 - b. Use a network discovery tool to find the address by connecting and disconnecting the Ethernet cable.
 - c. Set the meter to a static address using the serial interface
- 2) Connect your device to the same subnet as the PSHD meter
- 3) Open a web browser
- 4) Enter the PSHD's Ethernet address into the web browser

CONNECT TO WEB APP USING USB

In cases where the Ethernet port is already connected to a building network and the ViewPoint HD application has not been installed on the PC, the meter can still be configured using the meter's built-in web server.

- 1) Connect your device to the meter via USB cable
- 2) Open a web browser
- 3) Enter <http://169.254.1.5> (this is the static address of the USB port)

AUTHENTICATION

Because the PSHD Web App can be viewed and controlled by any device with a web browser and communicates in parallel to the host system, the PSHD can be configured to require a PIN# to restrict access the meter.

Enter the PIN#, if assigned, or leave blank, if unassigned, and press the Login button.

Organizationally, the PSHD Web App works much the same as ViewPoint HD, although it has no analytics and operates on a single element at a time.

macOS Users

ViewPoint HD is a Windows application and does not run on macOS. However, Mac users can make use of the PSHD Web App interface through the USB port by installing a CDC-EEM driver. This driver is available in the Media Distribution materials or can be downloaded from the DENT Instruments web site.

Name	Date modified	Type	Size
MAC	5/15/2018 9:13 AM	File folder	

Name	Date modified	Type	Size
dentinstruments-2.0.3a1.dmg	5/14/2018 9:44 AM	DMG File	2,048 KB
Read Me MAC.txt	5/15/2018 9:19 AM	Text Document	1 KB

- 1) Users must have OS version of 10.11.1 or higher
- 2) Drag the file dentinstruments-2.03a1.dmg onto the desktop
- 3) Double-click the dmg file to initiate the Mac installer
- 4) Follow the installation prompts
- 5) Reboot the Mac after the installation process is complete.
- 6) Connect the PSHD meter to the Mac with USB cable.
- 7) Open Safari browser and type IP address 169.254.1.5 to access the PSHD Web App
- 8) If no login credentials are setup, click on login button with blank for password
- 9) The PSHD Web App checks for login credentials and, if passed, opens Real Time Web Page

METER INSTALLATION - DETAILS



This section is intended to support the physical installation of the meter and provide guidance on connecting the current transformers (CTs) correctly within the electrical load center and to the PSHD meter.

Meter Mounting Configurations

DENT PowerScout HD meters are sold in several form factors. Wall mounted enclosures are designed to be connected to electrical conduit. Plate or rail versions are ready to be mounted inside a user-supplied UL/NEMA certified enclosure. Care should be taken to not flex the circuit board during mounting.

Mounting Options	PS48 HD/PS24 HD	PS12 HD	PS3HD
Enclosure			
OEM Plate			N/A

INSTALLATION SEQUENCE FOR WALL MOUNT ENCLOSURE MODELS

The following section illustrates the PS12HD-C-D-N model. The PS24HD-C-X-N, PS3HD-C-D-N, and PS48HD-C-X-N components are slightly different but follow the same procedure.

STEP 1) Remove top cover screws (4x) and high voltage cover screws (2x) – provided

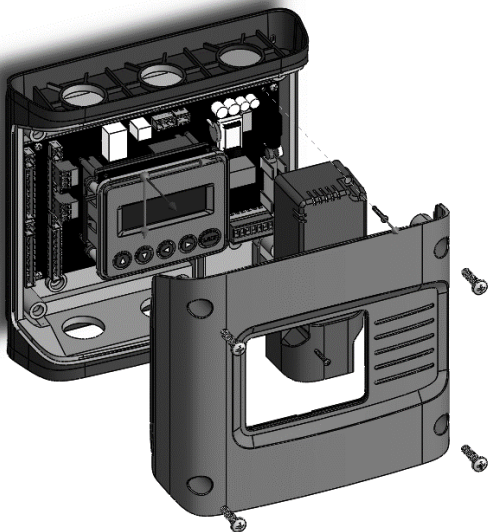

STEP 2) Locate, mark, and drill wall mounting points (2x–6x—user supplied)

The plastic enclosure itself can be used as a template for marking the drill locations on the wall.

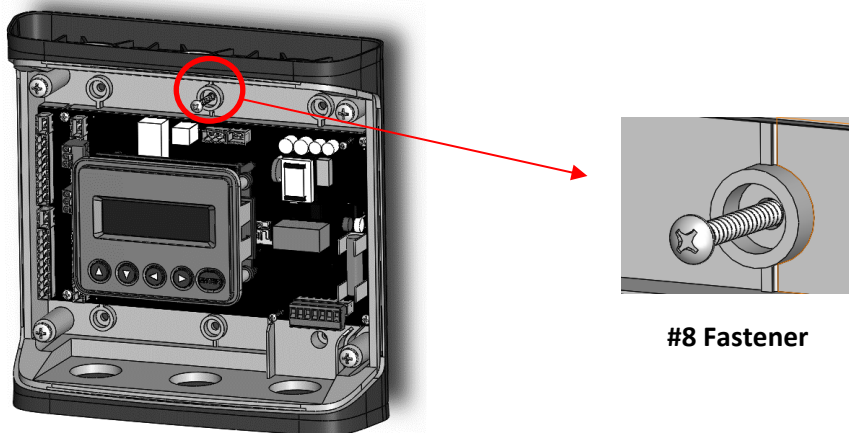

#8 Fastener

If the meter is not available for use as a drill template, a drawing indicating the spacing between mounting holes can be found in the appendix. The centerline holes are intended for fastening to wall studs. If hollow wall fasteners are used, the outer 4 mounting points are recommended.

STEP 3) Mount conduit fittings, conduits, and blanking plugs

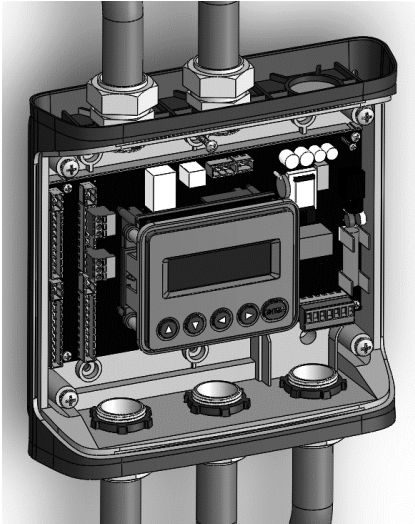

STEP 4) Connect voltage leads

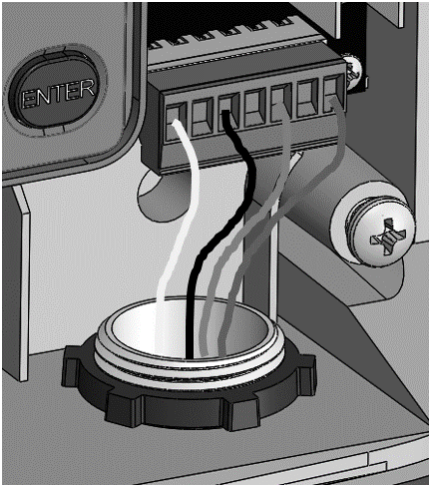

DO NOT ENERGIZE METER WITH VOLTAGE COVER REMOVED

STEP 5) Attach the TouchSaf™ high voltage cover

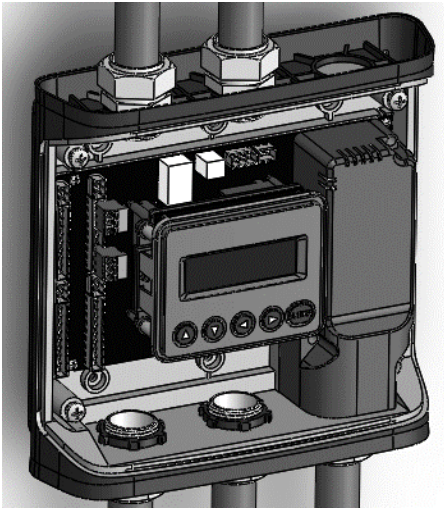

IP30



TOUCH SAFE (with internal high voltage cover installed)

STEP 6) Connect CT and Communications Wiring

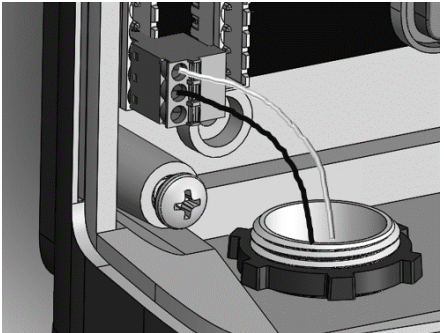

CONNECTING VOLTAGE

Connect the voltage leads (L1, L2, L3, and N, as necessary) to the meter through a dedicated disconnect or circuit breaker. A voltage lead of **14 AWG THHN Minimum 600VAC rating** (or equivalent) is required.



IMPORTANT: Verify the circuit breaker is marked as the disconnect breaker for the meter.

INSTALLATION SEQUENCE FOR PS3HD-R-D-N

The following section illustrates the PS3HD-R-D-N model, which is equipped with a built-in DIN rail channel for easy installation. The PS3HD-R-D-N must be installed inside a UL approved electrical enclosure.

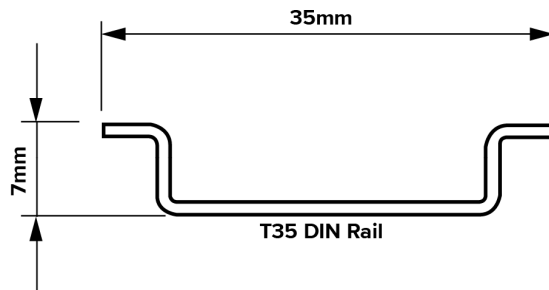

STEP 1) Within a suitable UL-approved enclosure, attach a section of T35 DIN rail on which the PS3HD will be mounted. Remember to leave enough clearance for voltage, CT, and communication wires to be routed within the enclosure. The UL-approved enclosure is customer supplied.

STEP 2) Mount the meter on the DIN rail by pressing the top edge of the DIN rail channel on the meter into the top of the DIN rail itself and then pushing the meter firmly towards the DIN rail so that it clicks into place. The meter can be released from the DIN rail by using a screwdriver to pull the DIN rail tabs at the bottom of the meter.

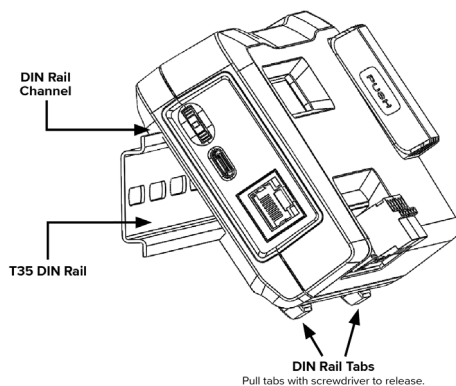

STEP 3) Remove the TouchSaf™ high voltage cover and connect the voltage leads to the meter.

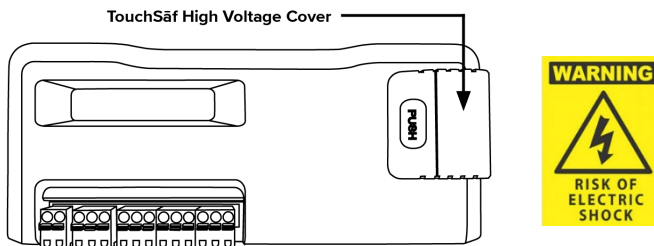

DO NOT ENERGIZE METER WITH VOLTAGE COVER REMOVED

STEP 4) Reattach the TouchSaf™ high voltage cover.

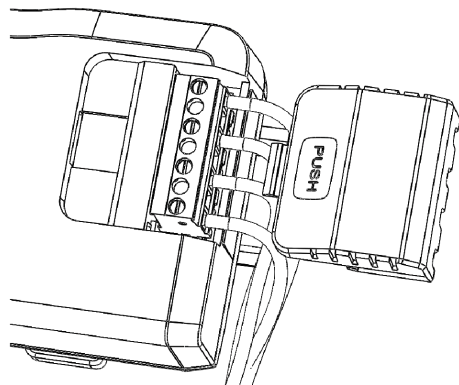

STEP 5) Connect CT and Communications Wiring.

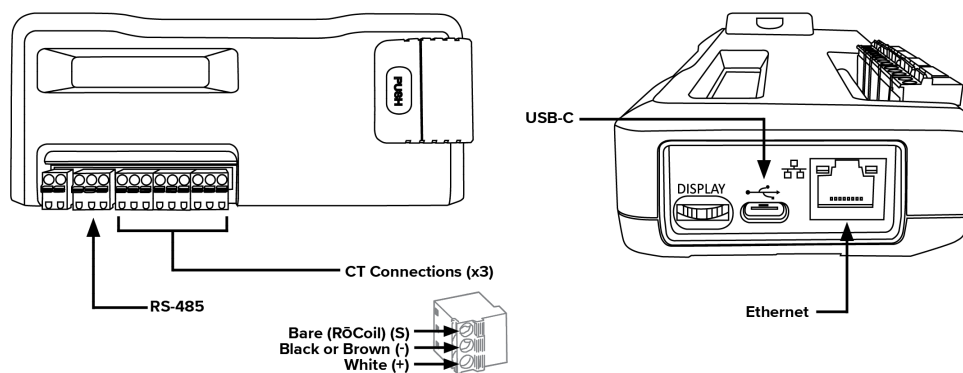

CONNECTING VOLTAGE

Connect the voltage leads (L1, L2, L3, and N, as necessary) to the meter through a dedicated disconnect or circuit breaker. A voltage lead of **14 AWG THHN Minimum 600VAC rating** (or equivalent) is required.



IMPORTANT: Verify the circuit breaker is marked as the disconnect breaker for the meter.

Wiring the PSHD Meter in a 3-wire, Split ϕ Service Panel



High voltage MAY BE PRESENT. Risk of electric shock. Life threatening voltages may be present. Qualified personnel only.

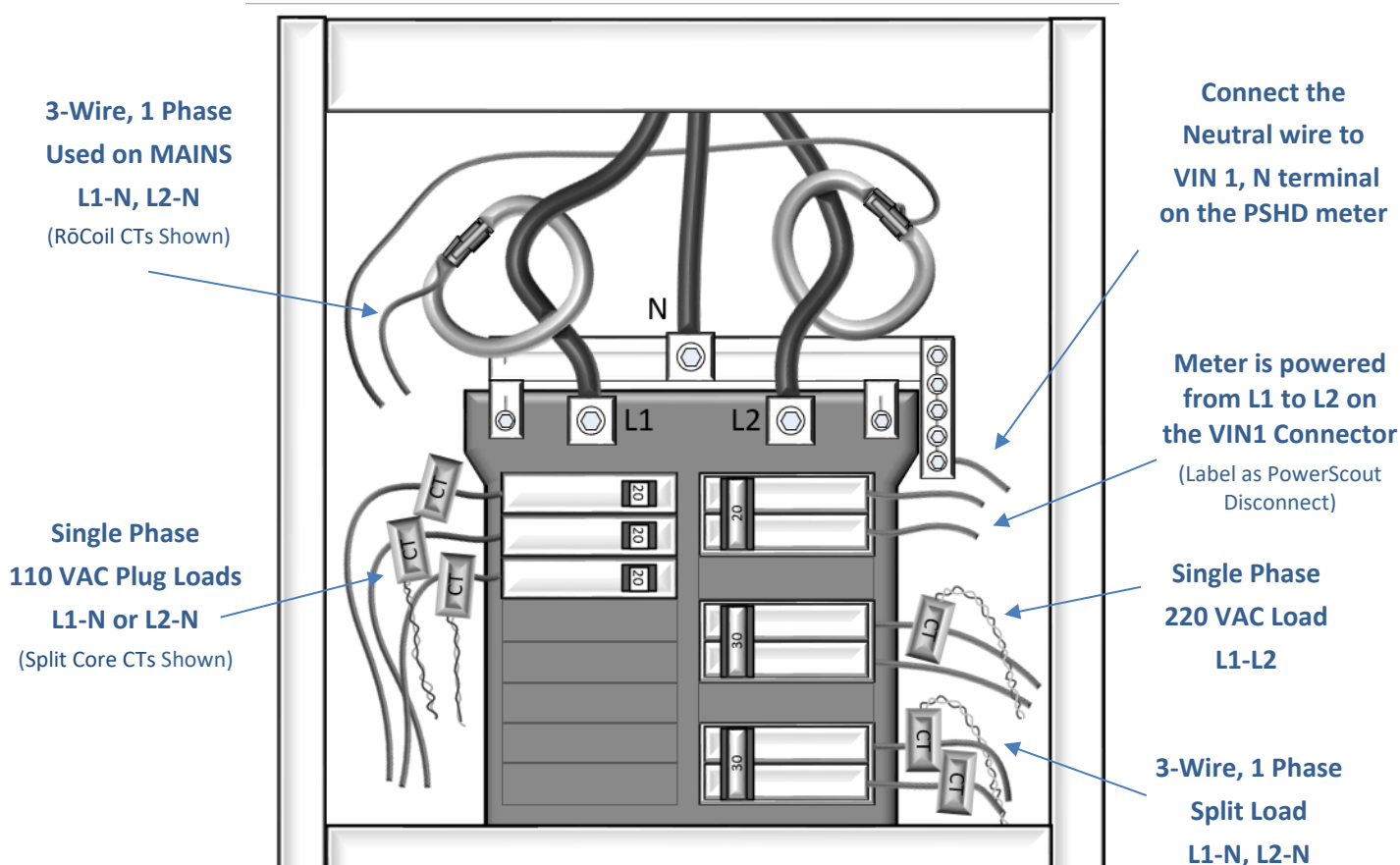

Illustrating the intended wiring configuration for each of the Service Types available in the Service drop-down list under “Meter Setup”

EXAMPLE LOADS:

Single Phase L1-N or L2-N 110 VAC: Lighting, Appliance, Living Zone

Single Phase L1-L2 220 VAC: Water Heater or other equipment with no Neutral wire

Split Phase L1-L2 220 VAC: Service Entrance, Dryers, or equipment with Neutral wire

Wiring the PSHD Meter in a 4-wire, 3 ϕ Service Panel

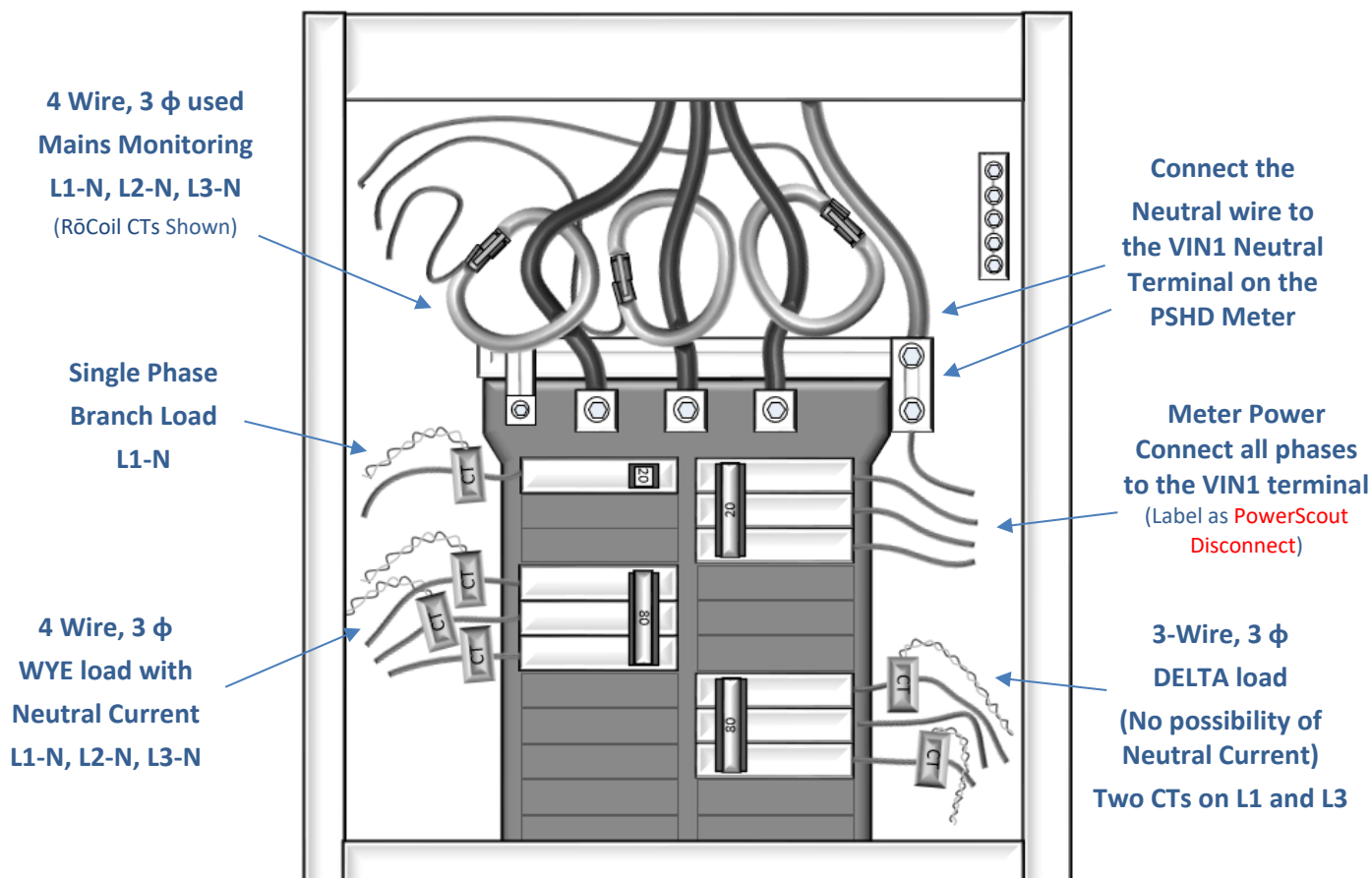

Illustrating the intended wiring configuration for each of the Service Types available in the Service drop-down list under “Meter Setup”



Note: The PSHD Meter Series uses the “Neutral” Terminal as a voltage reference. For systems without a neutral conductor, DENT Instruments suggests connecting a ground wire to this terminal. If the neutral terminal is left open, L-L measurements will be accurate, but L-N measurements may not be symmetric. If a ground wire is connected to the Neutral terminal, <500 uA will flow into the ground wire.

Wiring the PSHD Meter in a Single-Phase Application

The PSHD meter is internally powered through the voltage between L1 and L2. For Single Phase installations where no L2 exists it is advised to jumper N to L2. This connection provides power to the meter while maintaining Neutral as the metering voltage reference.

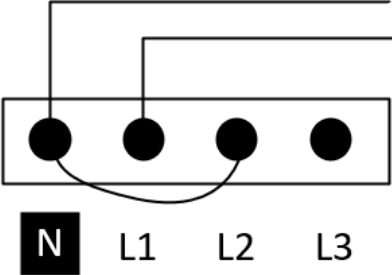

Current Transformer Basics

Ensure CTs meet the following criteria:



- 600 VAC UL Rated
- 333.3mV output voltage
- Appropriate range for the circuit (5-120% of CT Rating Recommended)

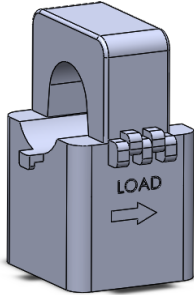

Ensure CT orientation & placement:

- Arrow points toward load (or as instructed by CT label)
- Arrow points away from Panel (or as instructed by CT label)
- Placed on First Conductor of voltage Reference (L1-L2) circuits are placed on L1
- Observe wiring color and polarity
- On RōCoils, use the Shield wire (connect to PCB terminal marked S)



Wiring Guide for CT Types	
Split, Hinged, & Solid Core CTs	RōCoil CTs
	
<p>White: Positive Black: Negative (no shield)</p>	<p>White: Positive Brown: Negative Bare Wire: Shield</p>

Wiring the CTs to Multi Circuit PSHD Meters

The image below is the counterpart to the service panel illustration and indicates how to connect CTs to the PSHD meter for each service type. For service types that are not specifically listed, it is recommended to choose “single phase” service and configure each channel individually. Three phase loads are illustrated on the left and split phase loads on the right as an example only. Elements are fully interchangeable on the meter.

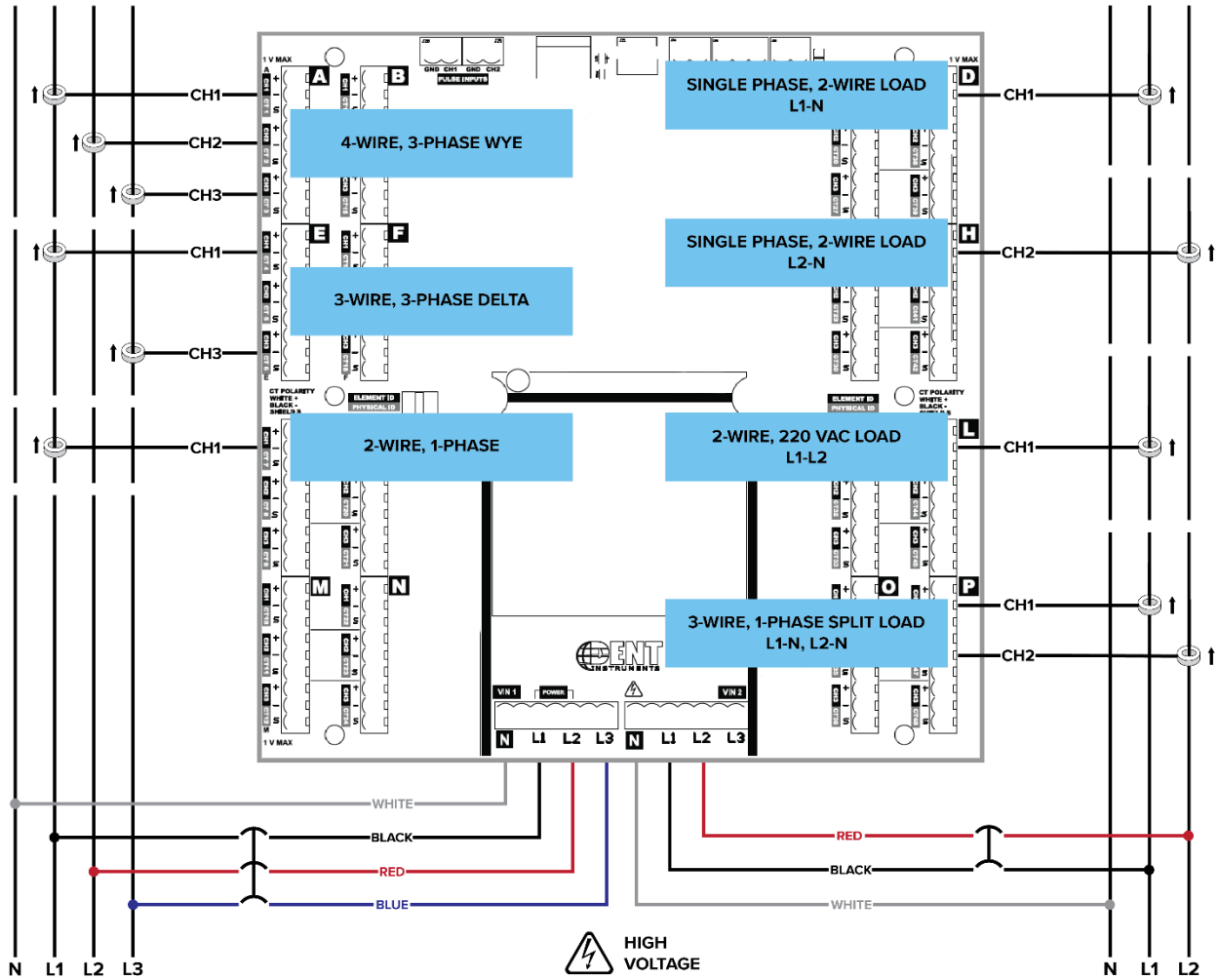

Wiring CTs to PS3HD Meters

The images below represent CT and voltage connections between the PowerScout 3 HD and the most common service types. For specific wiring questions outside the scope of this document, contact DENT technical support.

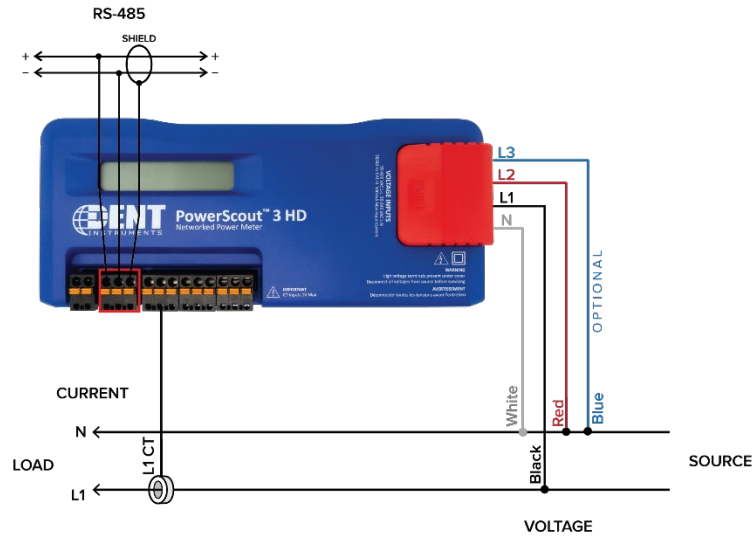

Two Wire Single Phase

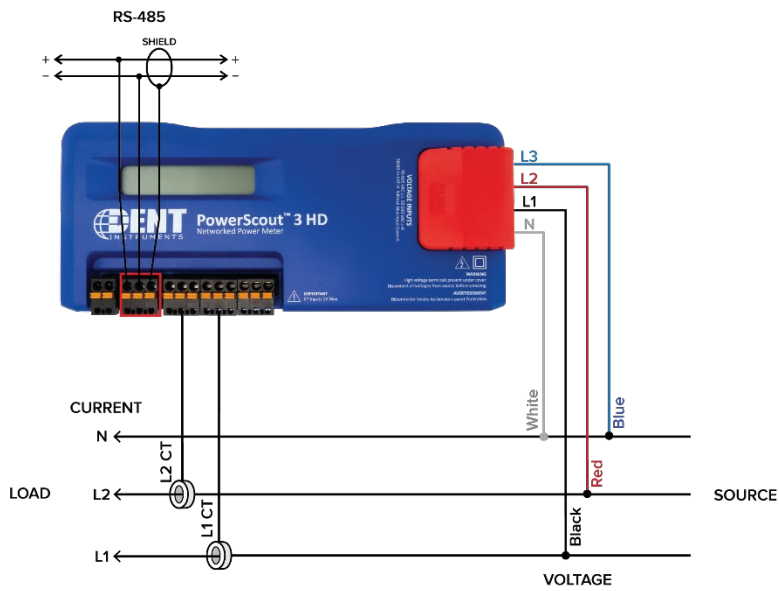

Three Wire Single Phase

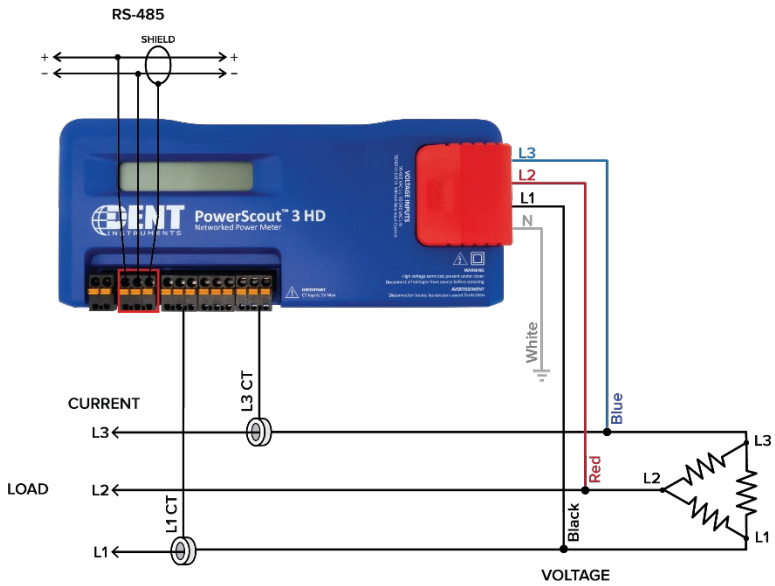

Two CT Three Wire Delta

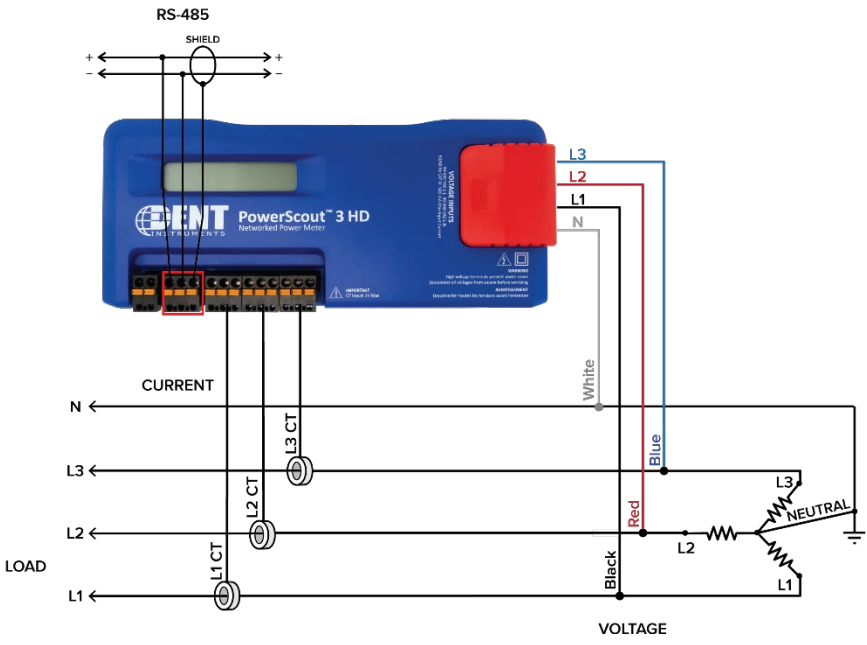

Four Wire Wye

COMMUNICATION & VERIFICATION - DETAILS



This section is intended to support the commissioning of the PSHD meter by an instrumentation technician. In many cases, the electrical installation is conducted ahead of the availability of the RTU or was performed by a different installer. Often the technician is working in concert with a remote programmer who is confirming the connectivity with a remote host system. A Digital Multimeter (DMM) can be used to confirm measurements at the board terminals, if necessary.



Once the meter is powered from line voltage, ONLY TOUCH WITH THE METER IF THE TOUCHSĀF™ HIGH VOLTAGE COVER IS INSTALLED. For multi-circuit meters, it is safe to touch the meter (including the user buttons) with the top cover removed ONLY if the TouchSāf™ high voltage cover is installed. Note: The PS12HD-P-D-N (mounting plate configuration) DOES NOT have a TouchSāf High Voltage Cover and should not be touched while powered from line voltage.



Communications settings and real-time data values can be confirmed quickly using the LCD interface if equipped. When significant setup modifications are anticipated, a computer interface is recommended.

Physical Connections on an RS-485 Multidrop Network

The PSHD meter uses a 2-Wire Half Duplex RS-485 Implementation.

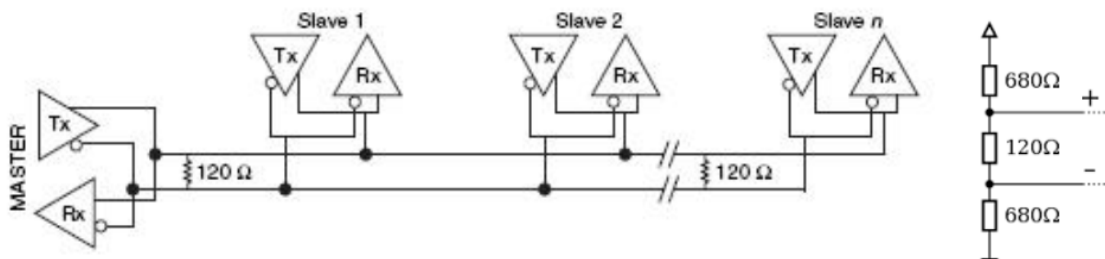

2-Wire Multidrop Network using Terminating Resistors

- **Termination Resistors**—are NOT included on the PSHD meter. If the PSHD meter is at the end of a daisy-chain, then connect a 120-ohm leaded resistor between the + and – terminal at the connector.
- **Bias Resistors**—are NOT included on the PSHD meter. Bias resistors are needed if the idle conditions of the bus are in an indeterminate logic voltage. Bias resistors are usually located at the master node and are usually 680 ohms for a RS-485 network.
- **Network Topology**—RS-485 is designed to be implemented as a **daisy chain** (series connections) rather than star or cascade topologies.

- **Signal Names**—Some RS-485 devices use the terminology A/B while others use +/- . Note that A is (-) and B is (+). Many manufacturers incorrectly label the terminals.
- **Bus Loading**—The PSHD meter is a 1/8th unit load allowing up to 256 like devices in parallel.

Communication Verification



Verification includes confirmation of BOTH the physical interface settings (Serial or Ethernet) and the protocol (Modbus or BACnet) settings.

The LCD User Interface can be used to quickly confirm the settings required for the desired interface and protocol. The interface is intuitive and groups together commonly associated registers. The complete interface for PS12HD/PS24HD/PS48HD is presented in Appendix A as a navigational map. Arrows indicate how to move from one menu display to the next. A **Reverse Contrast** entry in the documentation indicates the active menu item in a list which corresponds to a blinking character in the physical LCD. The ENTER button is used to select a property and up / down buttons are used to select among the values supported by the meter. Note that changes to the meter configuration are limited to the communication interface using the LCD. If additional changes (such as CT type) are required, they must be made using a software interface.

Because the LCD User Interface on the PS3HD is two lines instead of four, navigating the menu structure is different from the PS12HD, PS24HD, or PS48HD. Additionally, the PS3HD features a navigation thumb wheel which allows the user to scroll up or down and select menu options by pressing the thumb wheel. While the User Interface allows for checking real time values, it does not allow for advanced meter configuration. ViewPoint HD is the recommended configuration tool for the PS3HD.

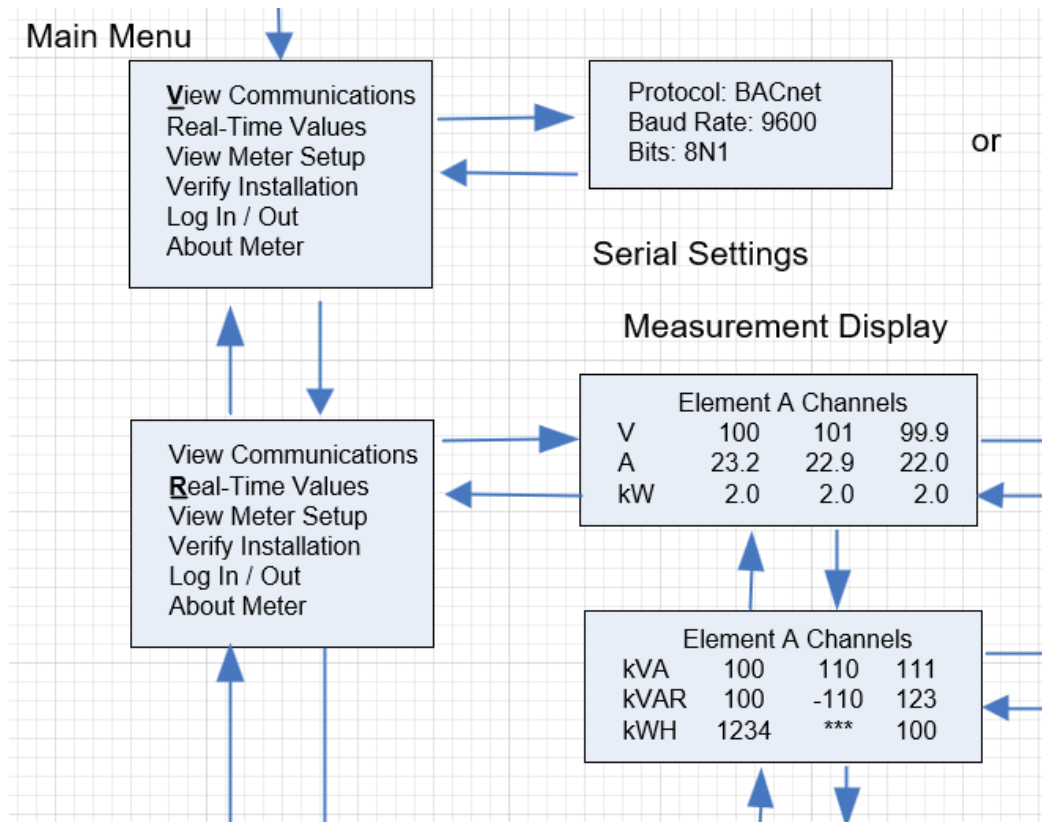

Example LCD Navigation

VIEWPOINT HD / PSHD WEB APP

If your PSHD model does not include the LCD User Interface, or if you prefer to verify the installation using software, then verification is facilitated through the ViewPoint HD PC application or the PSHD Web App, which share a common design. Refer to the section on Configuration Details for an overview and list of instructional videos for ViewPoint HD or the PSHD Web App.

Physical Interface Verification

SERIAL SETUP VERIFICATION

In a multidrop serial network, the host data format settings are typically known, or specified, and the slave is adjusted to match. In some cases (long wiring runs, etc.), it may be necessary to experiment in determining the fastest allowable baud rate for a given wiring configuration by changing BOTH the host and slave devices. Configurations other than 8N1 are rare and it is advised to use this configuration for Data Bits, Parity, and Number of Stop bits, if possible.

LAN ETHERNET NETWORK VERIFICATION

The PSHD meter communicates using IEEE 802.3 Ethernet connectivity running at a 10/100 Mbps. Verification of the meter settings over Ethernet includes ensuring that the IP address of the meter is within a range that allows communication with a host (if static) or is set for DHCP, allowing the meter to be assigned an address by a DHCP server as described below.

DHCP

If the PSHD meter is configured for DHCP when the meter is powered on, or the Ethernet cable is inserted, the meter is assigned an IP address by the DHCP server. This address appears on the meter's LCD user interface or can be found through connection with ViewPoint HD or the PSHD Web App. The IP address assigned to the meter should be regarded as a **temporary address** as the address may change between power cycles making it difficult for the host system to know how to find the meter on the network. One common approach is to set the PSHD for DHCP so that the address can be assigned by a DHCP server and then change that IP address to static once the connection is made. PSHD meters are set to use DHCP as a default setting to facilitate this approach.

STATIC IP

If the PSHD meter is set to a static IP, its address should be assigned by an IT department to avoid multiple devices on the same network. This scheme is usually used when an RTU is expecting to find the meter at a specific IP address.

Protocol Verification

The network protocol is typically specified as part of the installation. BACnet MS/TP and Modbus RTU are the two communication protocols that operate over an RS-485 serial network and BACnet IP and Modbus TCP are the protocols over Ethernet. Each combination of interface and protocol require specific registers settings described below. The scope of this section is to use either the LCD user interface or software tools to quickly confirm or change settings to match an existing specification. Further information and optimization tips are covered in the section on RTU programming.

Modbus Settings

MODBUS RTU SETTINGS

Device Address: In a Modbus network, each device must be assigned a **unique slave address**. Valid Modbus addresses are 1-240 (keep in mind the PS48HD requires 15 addresses beyond Element A, the PS24 requires 7 addresses beyond Element A, and the PS12HD requires 3 addresses beyond Element A). The slave address of the power meter sets the register address for **ELEMENT A**. Adjacent elements B, C, D, etc. are accessed by incrementing the slave address by 1. The slave address of the PSHD meter needs to be set to match the address expected by the RTU and is normally part of the network specification. The default address for Element A is 1.

MODBUS TCP SETTINGS

Modbus Port: The PSHD meter uses the industry standard Port 502 for Modbus. This port number cannot be changed.

BACnet Settings

BACnet Device ID: In a BACnet network, each device must be assigned a **unique Device ID and is common to BACnet MS/TP and BACnet IP protocols**. Besides the standard ability to change this from a BACnet explorer tool it may be changed via ViewPoint HD, PSHD Web App, or LCD user interface.

BACNET MSTP

Device Address: DENT meters are Master devices and, as such, must use MS/TP addresses in the range from 0-127. This address must be unique on the network.

Max Masters: The default setting is 127 and does not usually need to be changed.

Max Info Frame: The default setting is 1 and does not usually need to be changed.

BACNET IP

BACnet Port: The BACnet default port is 47808 and does not usually need to be changed.

BBMD: The BACnet/IP Broadcast Management Device is set to 0.0.0.0 at default and can be changed through a software tool to allow discovery across networks.

Pulse Outputs (Discontinued)

Early PS48HD meters (Hardware revision H running firmware version 1.012) were equipped with 2 pulse outputs. User feedback indicated that inputs would be more useful than outputs. In response to this, the pulse direction was reversed on the PS12HD and PS48HD meters. Pulse Output functionality is no longer supported. PCB's with terminals marked "Pulse Outputs" rather than "Pulse Inputs" have no functionality and should be left disconnected.

Pulse Inputs – PS12HD/PS24HD/PS48HD Only

PS12HD meters are equipped with 4 pulse inputs and PS24HD/PS48HD meters are equipped with 2 pulse inputs. Pulse counting supports accumulation of consumption data from any external meter using a dry contact (Form A Relay) or open collector outputs. The PSHD pulse inputs are compatible with "low speed" meters. The pulse duration must exceed 50 mS in both the logic low and high state allowing for a maximum input frequency of 10 Hz.

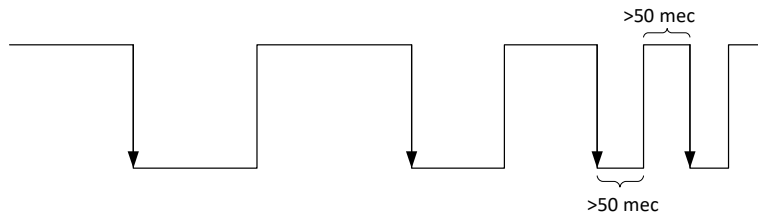

Pulse scaling, resetting and accumulated values are accessed through registers and are “system” in scope. Refer to the register list, ViewPoint HD, or videos for more information.

Alarm Output

Beginning in June 2020 the hardware alarm circuit in all PSHD meters is transitioning from electromechanical (SPDT) relays to an isolated open collector type (shown below). This transition has been made to focus on improving the behavior of the Voltage Phase Loss alarm response.

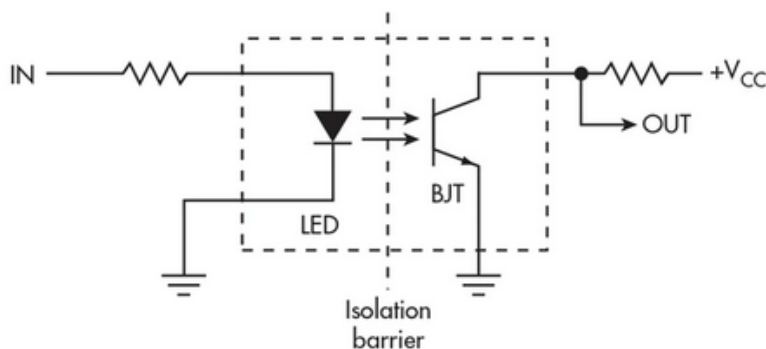

The alarm is designed to be connected to an external DC source between 5 and 24 volts and used with a customer supplied pullup resistor. A 10k-ohm ¼ watt resistor is the recommended load for this circuit.

For more information regarding setting up alarms see the section “Configuring Alarms” earlier in this manual.

Refer to the register list, ViewPoint HD, or instructional videos for more information.



Note: The Master Alarm relay is intended for low voltage DC connections.

12 Volt Auxiliary Power

The PS12HD, PS24HD, and PS48HD meters provide an auxiliary 12-volt output (200 mA max) that is derived from an auxiliary winding on the PSHD’s line-connected power supply. The 12-volt supply voltage is unregulated but protected by a self-resetting fuse. The purpose of the supply is to power external radio equipment or provide supply voltage for analog sensors, such as 4-20 mA current loop

devices. If full-rated current is drawn from this terminal, the minimum operating voltage of the L1-L2 power supply is 100 VAC.

This option is unavailable on the PS3HD.

Access Restriction Limitations

If security levels have been set up in the meter, no data is accessible through the LCD user interface or PSHD Web App without entering the PIN credentials. Note, however, that protocols such as Modbus do NOT SUPPORT ANY LEVEL of security such that any network traffic acting as a master can retrieve and write data from the registers. Generally, this will require knowledge of the IP address or slave ID and the register list which discourages casual intrusion.

Security PIN Protection

PSHD meters have two levels of PIN protection that users can choose to assign for restricting access to meter information. The PIN logic is described in the figure below. The **default** user entry (on power up or time-out) is **0000** which satisfies **both** the Read Only and the Read / Write default register settings.

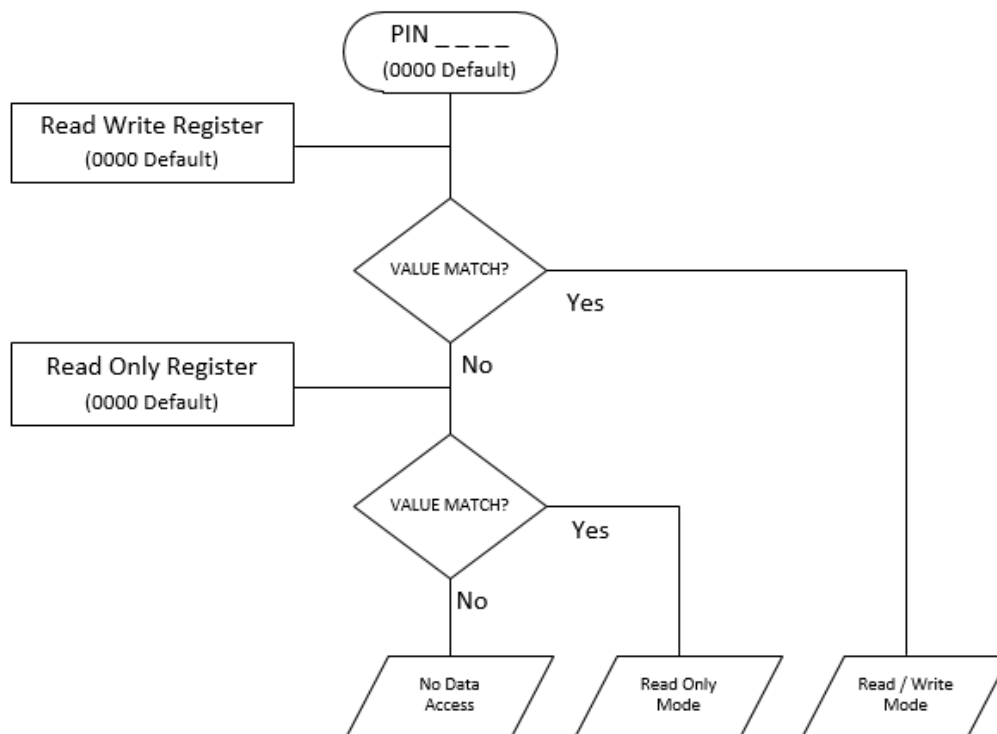

USING THE PERMISSION REGISTERS

The PSHD meter uses both a “Read Only” register and a “Read / Write” register to compare against user entries from the meter’s keypad or PSHD Web App form entry. Both internal permission registers have a default value of [0000]. A consequence of this is that both PIN registers need to be configured (i.e. changed from defaults) to implement a read only PIN. Otherwise, a situation may occur where a user intends to restrict access to “Read Only” by setting only this PIN unaware of the fact that the default PIN still matches the criteria for “Read / Write” which will accidentally promote the user. ViewPoint HD and the PSHD Web App disallow this condition, but remote programmers using direct register access may create this condition.

READ ONLY PERMISSION REGISTER

Configuring the meter for a Read Only user allows data or configuration items to be viewed but not changed. This level of authorization might be appropriate for general end-users, such as building owners, who may not be aware of the details of the installation. It is recommended to use ViewPoint HD to configure permissions, although it is also possible to set up a Read Only PIN using the PSHD Web App if a Read/ Write PIN has already been entered (either through the LCD user interface or the PSHD Web App itself).

READ/WRITE PERMISSION REGISTER

Read/Write permissions allow users to read and write configuration items and to reset the PINs. This level of authorization will be required by any technician or user who needs the ability to correct setup errors in the meter. The default PIN [0000] allows a new user to reset the Read / Write PIN from either the PSHD Web App or ViewPoint HD. Permissions cannot be set through the LCD interface.

READING PINs OVER MODBUS

ViewPoint HD can be used to directly report the Read Only and Read/ Write PINs under the Advanced Tab (passwords). The value reported by ViewPoint HD is the value as entered in the web page or LCD interface.

PINs are also accessible as Modbus registers but are encoded so that reading the value of the register through an RTU does not inform a user what the password is. This feature allows DENT Instruments to support retrieval of forgotten PINs if network access is available.

VIEWPOINT HD – UNRESTRICTED ACCESS

The ViewPoint HD software tool can be used to read and write configuration information to the meter without entering credentials.



ViewPoint HD is the preferred tool for setting up access restrictions because it allows users to test the function of the PINs without locking themselves out from the ability to change the PIN, a frustrating catch 22!

Verification of Installation

Once the PSHD meter is configured and communicating with the RTU, it is a good idea to perform some simple checks to ensure that all the CTs are on the correct voltage phases and that the CTs are facing the correct direction. The following are recommendations that work for typical installations. Special circuit conditions, like unloaded motors, may indicate an installation error when none exists. A Digital Multimeter (DMM) can be used to confirm these cases.

INSTALLATION PHASE VERIFICATION

The PSHD meter includes a PhaseChek™ algorithm that identifies any element that the meter suspects may be incorrectly phased (i.e., the CT is associated with the wrong voltage source or is physically on the wrong wire) based on power factors below 0.55. This feature is accessed using the LCD user interface by navigating to “VERIFY INSTALLATION” and pressing the ENTER button or locating within the scrolling window contents for a PSHD meter. The LCD user interface will list the elements having at least one channel with a low power factor.

CHECK ELEMENTS

A EF

Use the navigation buttons to highlight a specific element and hit enter or just hit enter and move from element to element using the ← / → keys. Within each element (identified on the top line of the display) the status of each channel is identified as OK (PF > 0.55) or bad (PF < 0.55).

ELEMENT F

CH1 OK

CH2 Bad

CH3 Bad

Two “Bad” channels are often an indication that two CTs are inadvertently swapped. When the power factor for all enabled channels is greater than 0.55, the meter reports:

CHECK ELEMENTS

ALL CHANNELS OK



PhaseChek™ is only applied for elements that are enabled. VIEW METER SETUP on the LCD user interface can be used to ensure that all intended elements are active. PhaseChek™ is advisory only. It is possible that the power factor for a particular load is truly less than 0.55, as may be observed in a free running motor.

The ViewPoint HD and the PSHD Web App run **PhaseChek™** continuously on all enabled elements and report low power factor in the real time values table by turning the text **RED** or by using a red indicator.

PHASE CHECKING BY PHASOR PLOT

When a CT is installed on the incorrect phase, the indicated current vector is pointing either 180 degrees away (a split phase system) or 120 degrees away (a three-phase system) from the true displacement angle. In the latter case, this usually causes a significant decrease in the reported power factor, even if the CT is also on backwards. When the absolute displacement power factor of a load is below 0.55 (an angle greater than 57 degrees between voltage and current), the PSHD meter will flag it as a phasing error. ViewPoint HD has a Phasor Plot feature that can be used to study the voltage and current vectors of a given meter element.

Check for Low Power Factor

- **ViewPoint HD:** Real Time Values > (All power factors < 0.55 are shown in RED)
- **PSHD Web App:** Real Time Values > (All power factors < 0.55 are shown in RED)
- **LCD User Interface:** Verify Installation > (LCD will list all elements having a PF < 0.55)

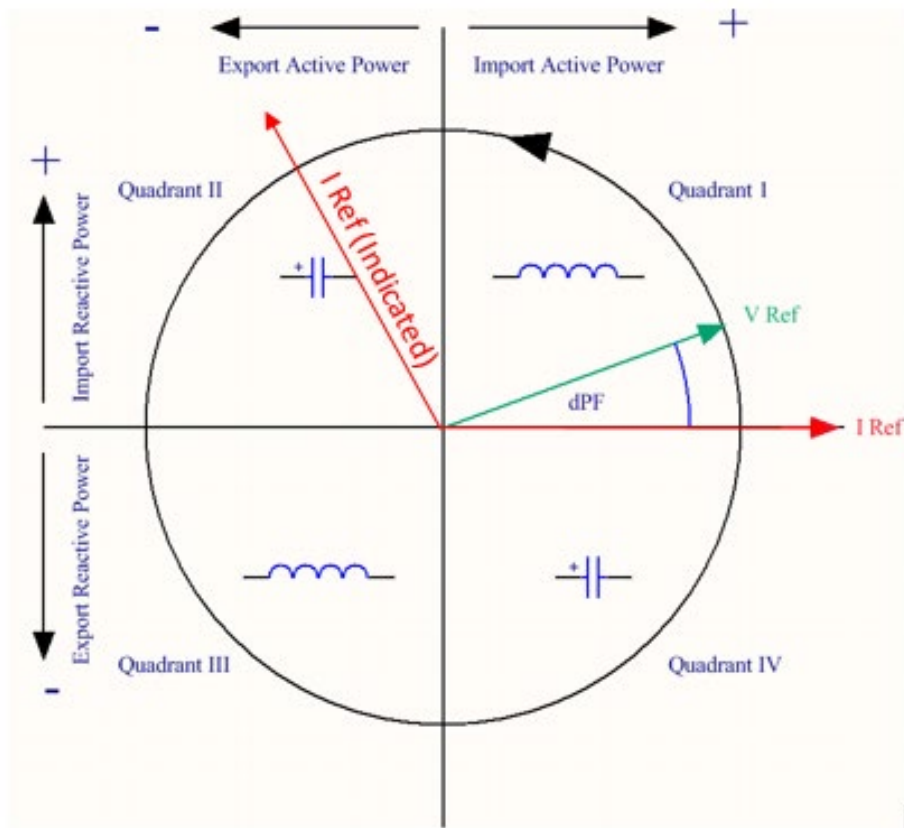

Electrical Power Quadrants with Incorrect CT Phase shown

CT Orientation Check

The PSHD meter reports power and energy in each electrical quadrant under a different register. When CTs are installed backwards, the indicated current vector is oriented 180 degrees away from the true displacement angle. In accordance with standard definitions, the Wattage and VARs of the effected channel report with a sign opposite from what is expected. Often this means that the import registers will be reading zero while the export registers are showing a value. Note that backward CTs have no impact on the amplitude of the Power Factor. A moderate power factor (>0.7) in concert with a negative power is a clue that the CT is on backwards but is on the correct phase.

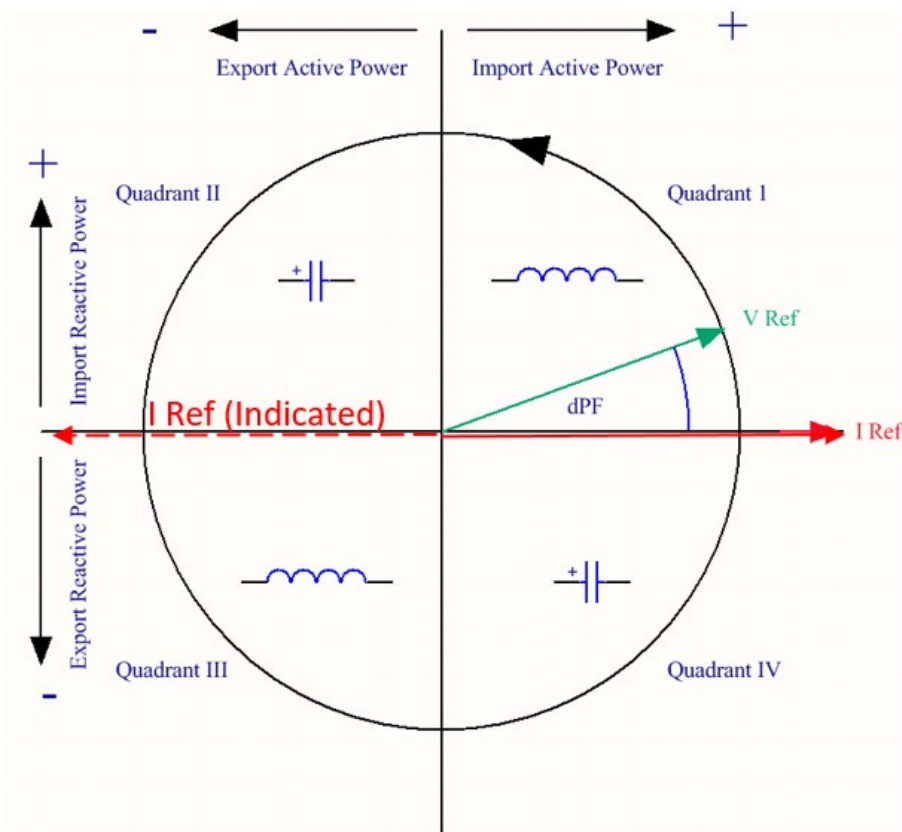

Electrical Power Quadrants with Reversed CT shown

Check that the wattage has the correct sign (Designated + for loads)

- **ViewPoint HD:** Real Time Values > (Confirm Sign of Power For All Elements)
- **PSHD Web App:** Real Time Values > (Confirm Sign of Power For All Elements)
- **LCD User Interface:** Real Time Values > (Confirm Sign of Power for Each Element)



If a CT is discovered to be on backwards after the installation is complete, the direction of the CT can be reversed through a user configuration register designed for this purpose called the “**Flipper**,” located at 2226, 2234, and 2235 or use ViewPoint HD’s meter setup.

Power Factor Convention

Power Factor is the ratio of a signed number (true power) and an unsigned number (apparent power). This discrepancy has led to some user confusion. The PSHD meter allows users to select between two conventions (ANSI & IEEE). In the IEEE convention, the sign of PF follows the sign of power itself. In the ANSI convention, a “+” PF indicates a lagging current (inductive load) while a “-” PF indicates a leading current (capacitive load). The sign relationships are shown below for these conventions in each electrical quadrant.

P.F.	Q1	Q2	Q3	Q4
ANSI	+	-	+	-
IEEE	+	-	-	+

Total Harmonic Distortion

The PSHD meter reports overall harmonic content in power (% THD) based on its measurement of Power, Var, and Apparent Power as illustrated in the figure below. This method cannot indicate the harmonic number or distribution but provides the overall harmonic content.

POWER TRIANGLE

(for active loads)

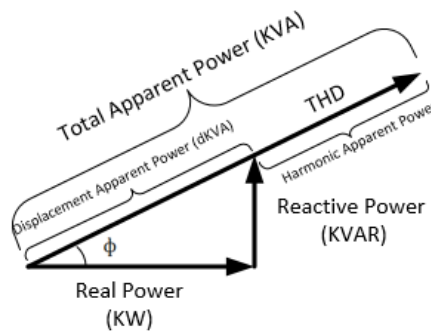

In many circumstances, users are interested in the harmonic content of **current**. In cases where the voltage is very sinusoidal, the THD measurement is a good estimate of both power and current. However, if the voltage waveform is distorted, the reported THD in power can be misleading. ViewPoint HD can provide additional analysis of harmonic content in voltage and current by sampling the PSHD raw data and performing digital signal processing on the signal. Using this method, the individual harmonics levels can be observed. The results are presented in graphical form.

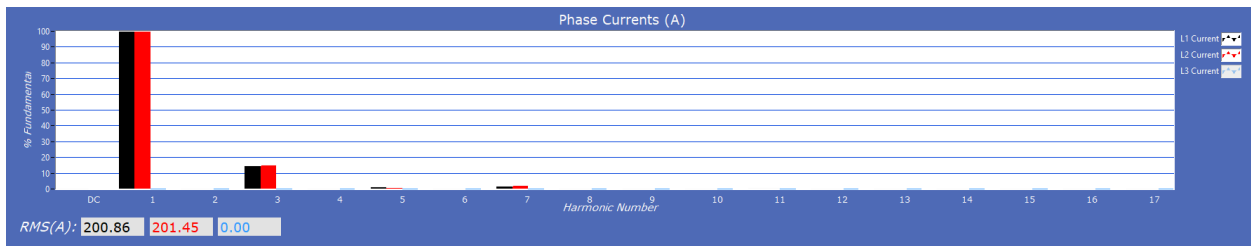

Pre-Processing Aids

The PSHD has several registers that can aid in pre-processing or post-processing data that otherwise may need secondary operations.

SNAP THRESHOLDS

The signal-to-noise ratio of the PSHD is above 80 dB at full scale (1 part in 10,000). When the signal amplitude becomes so small that it is indistinguishable from noise, it is often better to record 0 than a small, random value. Snap Threshold registers (*Advanced* tab in ViewPoint HD) tell the meter when to record 0 instead of the measurement result. The factory defaults for CTs are expressed in percent and have a default value of 0.04% Full Scale. The voltage thresholds are in absolute value, the recommended minimum voltage is 1.0 volt.



Changing the current Snap Threshold may affect the ANSI C12.20 compliance.

MULTIPLIERS

The PSHD has registers that allow potential transformers and series current transformers to be used with the PSHD meter. These registers allow for transformer winding ratios or other scaling adjustments to be included in the meter processing to eliminate post process scaling. Adjustments for voltage are global to the meter while CT's can be adjusted on a channel-by-channel basis. The multiplier is a floating-point number and can also be used for post installation calibration if desired. Default value is 1.0. Values below 0.9 are disallowed.

CT PHASE SHIFTS

Current transformers, like all other transformers, experience a small, magnetizing current that is out of phase with the measurement current. Phase shift registers are available on a per channel basis and allow corrections of +/- 4 degrees. ViewPoint HD loads the default phase shift for the CT types available in the picker list. If no phase shift information is available, enter the accuracy class in degrees (i.e. 1% = 1.0 degree).

DEMAND

PSHD meters keep track of electrical demand using a 15-minute sliding window. The *Peak Demand* and *Present Demand* registers contain the highest average power consumption in any 15-minute interval and the average power consumption in the last 15-minute interval, respectively. The Clear Peak Demand register is used to reset the peak demand detector.

RTU PROGRAMMING AND SCRIPTING - DETAILS



This section is intended for the programmer of an RTU or host system and includes details about meter and element addressing, register locations, data formats, and protocol examples.

Register Organization

The PSHD meter communicates through the reading and writing of registers. Registers are organized into functional groups and are based on the SunSpec Modbus interface model.

- SunSpec Common Registers
- SunSpec TCP Network Stack Registers
- SunSpec Serial Interface Registers
- SunSpec Energy Meter
- DENT Factory Registers
- DENT User Command Registers
- DENT User Configuration Registers
- DENT Metrology Registers
- DENT Waveform Capture Registers

The complete register set is included as an Excel file on the supplied thumb drive or at:

<https://www.dentinstruments.com/technical-documents/powerscout>

ELEMENT VS SYSTEM SCOPE

Element

The term “element” is used in two contexts. Physically, the term Element is used to describe groups of three channel sections identified by an alphabetic letter on the silk screen of the PS12HD, PS24HD, or PS48HD PCBA (i.e. A, B, C, D). In a three-phase power system, these correspond to electric circuits. Logically, the term Element describes the scope of a data item, register, or point (Modbus register or BACnet object). Each Element-based point is accessed by choosing the appropriate Modbus address, BACnet object range, or BACnet structured view. Elements in turn have points that refer to individual channels or to SUMS or AVERAGES of those channels. Registers that contain data inclusive of more than one channel are identified as being either SUMS or AVERAGES of the enabled channels within an element. In a BACnet structured view, an Element represents a level of organization for related points.

Channel

Channels are identified on the meter as CH1, CH2, or CH3 and represent physical CT inputs. In three-phase system configurations, these correspond to a current load on a corresponding line voltage. In single phase configurations, they are just used to identify a CT location. Registers providing data for an individual channel are also described as elements in their scope as a unique value exists for each Slave Address or BACnet object instance.

System

The term **“System”** refers to registers defining the characteristics of the entire circuit board. System registers report the same value independent of the slave address. Under BACnet structured view, the system points are grouped together.

PHYSICAL IMPLEMENTATION ON PS48HD METERS

Starting in 2020, an update to the PS12, PS24, and PS48HD circuit board has been implemented as a rolling change to accommodate two nomenclatures for CT identification. In addition to the “Classic” nomenclature (Alpha Letter and CH #) CTs are also identified by a unique CT # (1-48 for example). The CT# nomenclature will be used to allow users to group CT channels into “Virtual Elements” that are not constrained to a three-phase structure and have additional flexibility. To suit both Classic and Virtual Element (VE) meters with the same base design, the printed circuit board has been revised to indicate both nomenclatures using a two-color silk screen, something like a scientific calculator (see image at right showing Element E)

1. The Classic meter nomenclature (A, B, C... CH1, CH2, CH3) will be shown in **white** ink.
2. The Virtual Element nomenclature will use the terminology CT# instead of CH# and will be shown in **yellow** ink.

The Virtual Element configuration tools and supporting firmware will be available beginning in 2021 in conjunction with IOT features, stay tuned!

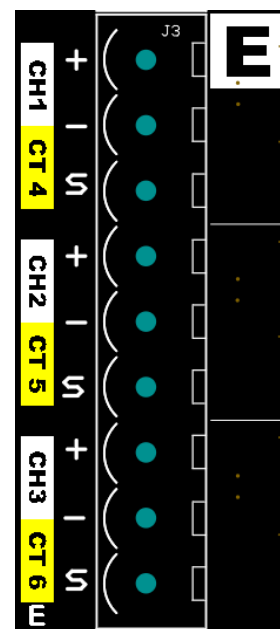

CONFIGURING ELEMENT AND CHANNEL REGISTER FOR SERVICE TYPES

The ViewPoint HD software enforces all element configurations to form a valid electrical system. Configurations performed by remote systems may produce unexpected results if configurations are internally inconsistent. The following tables document how to configure element and channel registers for each service type. Every register should be explicitly written.

Red Text indicates Required Values, **Purple Text** indicates Suggested Defaults, if this data is not known.

Modbus Absolute Address/BACnet Object Assignments for Setting up Service Types

REGISTER TEMPLATE						
Service Type	2207					
V_Input	2217					
Description	2617					
Channels	Volt Ref	CT Type	Range	Phase Shift	CT Multiplier	CT Sign
CH1	2220	2223	2218,2219	2224,2225	2221,2222	2226
CH2	2229	2232	2227,2228	2233,2234	2230,2231	2235
CH3	2238	2241	2236,2237	2242,2243	2239,2240	2244

Configurations

4 Wire 3 φ (Wye)						
Service Type	1					
V_Input	1 or 2					
Description	31 Char					
Channels	Volt Ref	CT Type	Range	Phase Shift	CT Multiplier	CT Sign
CH1	L1 – N [1]	mV [1] or RōCoil [2]	Any > 0A	-4.0° to +4.0°	Any > 0 [1]	0 or 1
CH2	L2 – N [2]	mV [1] or RōCoil [2]	Any > 0A	-4.0° to +4.0°	Any > 0 [1]	0 or 1
CH3	L3 – N [3]	mV [1] or RōCoil [2]	Any > 0A	-4.0° to +4.0°	Any > 0 [1]	0 or 1

3 Wire 3 φ (Delta)						
Service Type	2					
V_Input	1 or 2					
Description	31 Char					
Channels	Volt Ref	CT Type	Range	Phase Shift	CT Multiplier	CT Sign
CH1	L1 – N [1]	mV [1] or RōCoil [2]	Any > 0A	-4.0° to +4.0°	Any > 0 [1]	0 or 1
CH2	L2 – N [2]	mV [1] or RōCoil [2]	Same as 1	Same as 1	Same as 1	0 or 1
CH3	L3 – N [3]	mV [1] or RōCoil [2]	Same as 1	Same as 1	Same as 1	0 or 1

Even though CH2 is calculated internally, it is recommended that the CT settings reflect those from CH1, rather than being left at factory default, to facilitate configuration validation from the RTU.

2 Wire 1 ϕ (Plug Load)						
Service Type	3					
V_Input	1 or 2					
Description	31 Char					
Channels	Volt Ref	CT Type	Range	Phase Shift	CT Multiplier	CT Sign
CH1	ANY [1-6]	mV [1] or R \ddot{o} Coil [2]	Any > 0A	-4.0 $^{\circ}$ to +4.0 $^{\circ}$	Any > 0 [1]	0 or 1
CH2	ANY [1-6]	mV [1] or R \ddot{o} Coil [2]	Any > 0A	-4.0 $^{\circ}$ to +4.0 $^{\circ}$	Any > 0 [1]	0 or 1
CH3	ANY [1-6]	mV [1] or R \ddot{o} Coil [2]	Any > 0A	-4.0 $^{\circ}$ to +4.0 $^{\circ}$	Any > 0 [1]	0 or 1

Any channel that needs to be turned OFF should set the CT Type to OFF [0].

3 Wire 1 ϕ (Split Phase)						
Service Type	4					
V_Input	1 or 2					
Description	31 Char					
Channels	Volt Ref	CT Type	Range	Phase Shift	CT Multiplier	CT Sign
CH1	L1 – N [1]	mV [1] or R \ddot{o} Coil [2]	Any > 0A	-4.0 $^{\circ}$ to +4.0 $^{\circ}$	Any > 0 [1]	0 or 1
CH2	L2 – N [2]	mV [1] or R \ddot{o} Coil [2]	Any > 0A	-4.0 $^{\circ}$ to +4.0 $^{\circ}$	Any > 0 [1]	0 or 1
CH3	L3 – N [3]	OFF [0]	Any > 0A	-4.0 $^{\circ}$ to +4.0 $^{\circ}$	Any > 0 [1]	0 or 1

Even though CH3 is not used for computation it is recommended that the CT settings reflect those from CH1 rather than being left at factory default to facilitate configuration validation from the RTU.

Disabled (OFF)						
Service Type	5					
V_Input	1 or 2					
Description	31 Char					
Channels	Volt Ref	CT Type	Range	Phase Shift	CT Multiplier	CT Sign
CH1	L1 – N [1]	OFF [0]	Any > 0A	-4.0 $^{\circ}$ to +4.0 $^{\circ}$	Any > 0 [1]	0 or 1
CH2	L2 – N [2]	OFF [0]	Any > 0A	-4.0 $^{\circ}$ to +4.0 $^{\circ}$	Any > 0 [1]	0 or 1
CH3	L3 – N [3]	OFF [0]	Any > 0A	-4.0 $^{\circ}$ to +4.0 $^{\circ}$	Any > 0 [1]	0 or 1

Even though disabled channels are not used in calculations and report 0.0 they still contain configuration information. It is suggested that they be set to a known value rather than left at defaults to facilitate configuration validation by the RTU.

CONFIGURING SYSTEM REGISTERS

Modbus Absolute Address/BACnet Object Assignment

REGISTER TEMPLATE	
Description	2601
PF Sign Convention	2248
V1 Multiplier	2203,2204
V2 Multiplier	2205,2206

Configurations

System	
Description	31 Char
PF Sign Convention	ANSI [1] or IEEE[2]
V1 Multiplier	Any > 0 [1 default]
V2 Multiplier	Any > 0 [1 default]

Modbus Protocol Commands

If configured for Modbus, the PSHD networked power meter family follows the Modbus RTU protocol and supports the following command set.

Supported Modbus Commands		
Command Name	Command Number	Description
Read Holding Registers	03	Used to read the data values from the PSHD meter
Write Single Register	06	Used to write a single holding register to a PSHD meter
Write Multiple Registers	16 (0x10)	Used to write multiple registers (useful but not required for 32-bit values and strings)
Report Slave ID	17 (0x11)	Used to read information from the identified PSHD meter

SLAVE ADDRESS

For Modbus/TCP, the base slave address (or “unit address,” as the Modbus TCP specification calls it) is fixed at 1.

Refer to the section “Serial Protocols” for additional information on setting the Slave Address and finding the address of a specific meter element.

MODBUS STRING ENTRY

Registers that are identified as “strings” are handled uniquely by the PSHD power meter. Each register in the string block must be written to sequentially, without interruption, either by using a “write multiple” command or by sending single register commands back to back. The final character in the string **MUST** be a NULL character (ASCII 0). The meter will process the entire string only if these two conditions are met, otherwise the data is ignored. This special processing has been implemented to protect partial updates for network settings.

String example 1: Change a Static IP Address

Change the IP address of a meter from 192.168.2.8 to 192.168.2.9

It may be tempting to update only the digit “8” to “9” in the IP address, but this will NOT perform as expected. Internally, the meter uses a single string buffer for all string register operations and unspecified entrees will continue to contain the previous buffer contents unless specifically written to. Write every register from the beginning of the block to the end.

Reg (dec)	1079	1080	1081	1082	1083	1084	1085	1086
Reg (hex)	04 37	04 38	04 39	04 3A	04 3B	04 3C	04 3D	04 3E
Value (Chr)	'1' '9'	'2' \.'	'1' '6'	'8' \.'	'2' \.'	'9' NUL	NUL NUL	NUL NUL
Value (hex)	31 39	32 2E	31 36	38 2E	32 2E	39 00	00 00	00 00
	START							STOP

Specific Implementation Examples – Element A set to ID 1

Note that in Modbus the CRC communicated is LSB then MSB.

VIA MODBUS RTU (SERIAL) USING FUNCTION CODE 6 / WRITE SINGLE REGISTER

```

ID FC ADDR DATA CRC
01 06 04 37 31 39 EC B6
01 06 04 38 32 2E 9C 4B
01 06 04 39 31 36 CD 71
01 06 04 3A 38 2E 3B 2B
01 06 04 3B 32 2E 6C 4B
01 06 04 3C 39 00 5A A6
01 06 04 3D 00 00 19 36
01 06 04 3E 00 00 E9 36
    
```

VIA MODBUS RTU (SERIAL) USING FUNCTION CODE 16 / WRITE MULTIPLE REGISTER

```

ID FC ADDR #REGS LN DATA0 DATA1 DATA2 DATA3 DATA4 DATA5 DATA6 DATA7 CRC
01 10 04 37 00 08 10 31 39 32 2E 31 36 38 2E 32 2E 39 00 00 00 00 00 9B 99
    
```

VIA MODBUS TCP (ETHERNET) USING FUNCTION CODE 6 / WRITE SINGLE REGISTER

```

TXNID PROID LENGT ID FC ADDR DATA (TXNID will be arbitrary)
01 87 00 00 00 06 01 06 04 37 31 39
01 88 00 00 00 06 01 06 04 38 32 2E
01 89 00 00 00 06 01 06 04 39 31 36
01 8A 00 00 00 06 01 06 04 3A 38 2E
01 8B 00 00 00 06 01 06 04 3B 32 2E
01 8C 00 00 00 06 01 06 04 3C 39 00
01 8D 00 00 00 06 01 06 04 3D 00 00
01 8E 00 00 00 06 01 06 04 3E 00 00
    
```

VIA MODBUS TCP (ETHERNET) USING FUNCTION CODE 16 / WRITE MULTIPLE REGISTER

```

TXNID PROID LENGT ID FC ADDR #REGS LN DATA0 DATA1 DATA2 DATA3 DATA4 DATA5 DATA6 DATA7
01 87 00 00 00 17 01 10 04 37 00 08 10 31 39 32 2E 31 36 38 2E 32 2E 39 00 00 00 00 00
    
```

String example 2: Element Description

Change the Element Description from “Mains Bld 100” to “Mains Bld 101”

It may be tempting to update only the character number “0” to “1” in the description, but this will NOT perform as expected. Internally, the meter uses a single string buffer for all string register blocks and unspecified entrees will continue to contain the previous buffer contents unless specifically written to.

Reg (dec)	2617	2618	2619	2620	2621	2622	2623	2624	2625	2626	2627	2628	2629	2630	2631	2632
Reg (hex)	0A 39	0A 3A	0A 3B	0A 3C	0A 3D	0A 3E	0A 3F	0A 40	0A 41	0A 42	0A 43	0A 44	0A 45	0A 46	0A 47	0A 48
Value (Chr)	'M' 'a'	'i' 'n'	's' ''	'B' 'l'	'd' ''	'1' '0'	'1' Nul	NulNul	NulNul	NulNul	NulNul	NulNul	NulNul	NulNul	NulNul	NulNul
Value (hex)	4D 61	69 6E	73 20	62 6C	64 20	31 30	31 20	00 00	00 00	00 00	00 00	00 00	00 00	00 00	00 00	00 00
	START															STOP

Specific Implementation Examples – Element A set to ID 1

VIA MODBUS RTU (SERIAL) USING FUNCTION CODE 6 / WRITE SINGLE REGISTER

```

ID FC ADDR DATA CRC
01 06 0A 39 4D 61 AE A7
01 06 0A 3A 69 6E 05 A3
01 06 0A 3B 73 20 DF 37
01 06 0A 3C 62 6C 63 53
01 06 0A 3D 64 20 30 C6
01 06 0A 3E 31 30 FE 5A
01 06 0A 3F 31 20 AE 56
01 06 0A 40 00 00 8B C6
01 06 0A 41 00 00 DA 06
01 06 0A 42 00 00 2A 06
01 06 0A 43 00 00 7B C6
01 06 0A 44 00 00 CA 07
01 06 0A 45 00 00 9B C7
01 06 0A 46 00 00 6B C7
01 06 0A 47 00 00 3A 07
01 06 0A 48 00 00 0A 04
    
```

VIA MODBUS RTU (SERIAL) USING FUNCTION CODE 16 / WRITE MULTIPLE REGISTER

```

ID FC ADDR #REGS LN DAT00 DAT01 DAT02 DAT03 DAT04 DAT05 DAT06 DAT07
01 10 0A 39 00 10 20 4D 61 69 6E 73 20 62 6C 64 20 31 30 31 20 00 00

DAT08 DAT09 DAT10 DAT11 DAT12 DAT13 DAT14 DAT15 CRC
00 00 00 00 00 00 00 00 00 00 00 00 00 00 00 00 3A 18
    
```

VIA MODBUS TCP (ETHERNET) USING FUNCTION CODE 6 / WRITE SINGLE REGISTER

TXNID PROID LENGT ID FC ADDR DATA (TXNID will be arbitrary)

```
01 87 00 00 00 06 01 06 0A 39 4D 61
01 88 00 00 00 06 01 06 0A 3A 69 6E
01 89 00 00 00 06 01 06 0A 3B 73 20
01 8A 00 00 00 06 01 06 0A 3C 62 6C
01 8B 00 00 00 06 01 06 0A 3D 64 20
01 8C 00 00 00 06 01 06 0A 3E 31 30
01 8D 00 00 00 06 01 06 0A 3F 31 20
01 8E 00 00 00 06 01 06 0A 40 00 00
01 8F 00 00 00 06 01 06 0A 41 00 00
01 90 00 00 00 06 01 06 0A 42 00 00
01 91 00 00 00 06 01 06 0A 43 00 00
01 92 00 00 00 06 01 06 0A 44 00 00
01 93 00 00 00 06 01 06 0A 45 00 00
01 94 00 00 00 06 01 06 0A 46 00 00
01 95 00 00 00 06 01 06 0A 47 00 00
01 96 00 00 00 06 01 06 0A 48 00 00
```

VIA MODBUS TCP (ETHERNET) USING FUNCTION CODE 16 / WRITE MULTIPLE REGISTER

TXNID PROID LENGT ID FC ADDR #REGS LN DAT00 DAT01 DAT02 DAT03 DAT04 DAT05

```
01 87 00 00 00 27 01 10 04 37 00 10 20 4D 61 69 6E 73 20 62 6C 64 20 31 30
```

DAT06 DAT07 DAT08 DAT09 DAT10 DAT11 DAT12 DAT13 DAT14 DAT15

```
31 20 00 00 00 00 00 00 00 00 00 00 00 00 00 00 00 00 00 00
```

Floating Point Registry Entry

The PSHD meter uses 32-bit IEEE 754 formatted floating point numbers for reporting results and storing scalable user register values such as CT range, CT and PT scaling factors, etc. Because these registers require two 16-bit Modbus addresses to convey, these registers must be accessed as multiple registers or accessed sequentially without interruption. The reason for preventing floating point registers from being updated as single 16-bit registers is that interim values (when the number is half entered) represent valid but unknown numeric values! Requiring both the MSW and LSW registers to be written sequentially prevents meter data from having unknown and potentially very large scaling factors applied to measurement data between register writes.

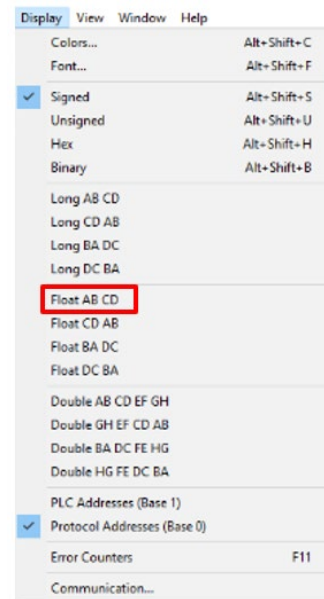

SELECTING THE DATA TYPE

It is likely that the RTU program has built-in support for multiple data types including floating point. The PSHD meter data is stored as MSW, LSW which may take some trial and error to identify in the RTU setup. Float ABCD is an example of the how this RTU identifies the matching byte order.



It is anticipated that command-line programmers or script writers may prefer to enter data in hexadecimal format. Non-programmers using Modbus or BACnet utilities (or those using ViewPoint HD) may prefer to use decimal notation. This example works through the details of converting information found in our user documentation (decimal) into a hexadecimal format which should cover the highest level of complexity.

Entering Floating Point Data Using a Script

Consider the process of setting the CH1 CT Full Scale Rating to a value of 100.00 amps for a meter having an element at slave address #1.

Step 1) Convert 100.00 into an IEEE 754 floating point format by entering the number in a conversion utility.

- a. Internet Utility. Example: <https://www.h-schmidt.net/FloatConverter/IEEE754.html>
- b. ViewPoint HD

a) Internet Utility

The 16-bit floating point representation of 100.00 is shown below as **0x42C8 0x0000**. These are the required MSW and LSW register contents, respectively.

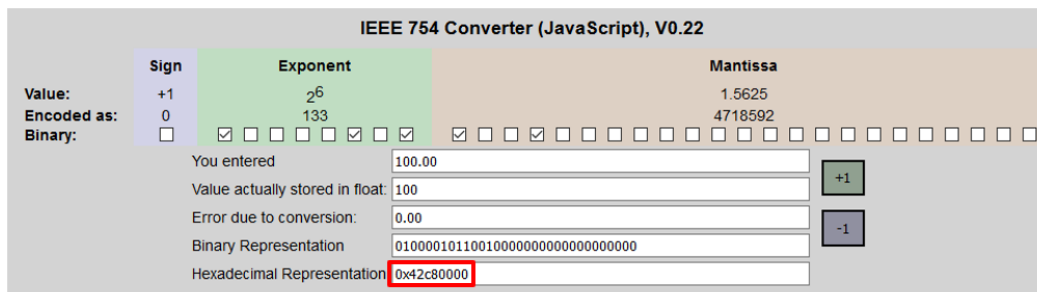

b) ViewPoint HD.

If an internet utility is not available, ViewPoint HD has a built-in conversion utility under the *Advanced Tab*. Enter 100.00 and press the “Convert to Modbus Integers” button.

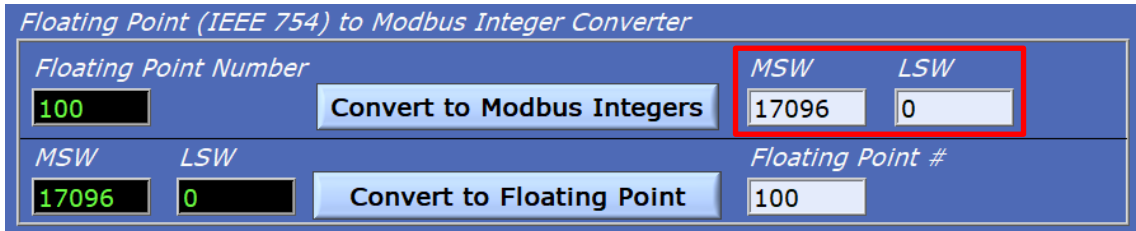

This utility identifies that the MSW and LSW registers need to be set to 17096 & 0 (decimal) respectively. If hexadecimal notation is required, these decimal values can be converted using a utility such as the MS Windows Calculator (under Programmer mode) as shown below.

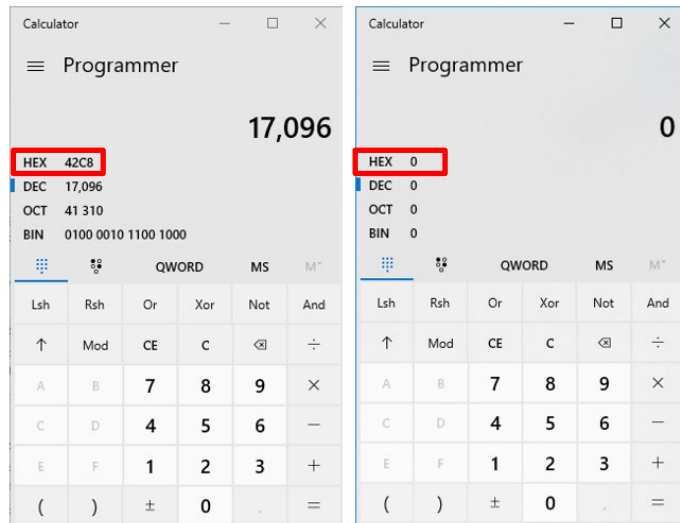

After padding, we also arrive at 0x42C8 0x0000 as the MSW and LSW register values, respectively.

Step 2) Identify which configuration registers control the CH1 CT Full Scale Rating

- a. Refer to the MS Excel Register List (USB drive or at www.DENTinstruments.com)
 - b. Use ViewPoint HD to discover the address of displayed data.
- a) Open the MS Excel Register List and locate the CH1 CT Full Scale Rating Registers under USER CONFIG POINTS group.

Modbus Register Name	Modbus Register	Absolute Address
CH1 CT Full Scale Rating (MSW)	2218	42219
CH1 CT Full Scale Rating (LSW)	2219	42220

- b) Connect to a PSHD meter using ViewPoint HD. Navigate to the Meter Setup tab and press the ? icon. Hover over the Element A setup portion of the window. This launches the Context Help popup and indicates the addresses of the registers controlled or displayed by this window.

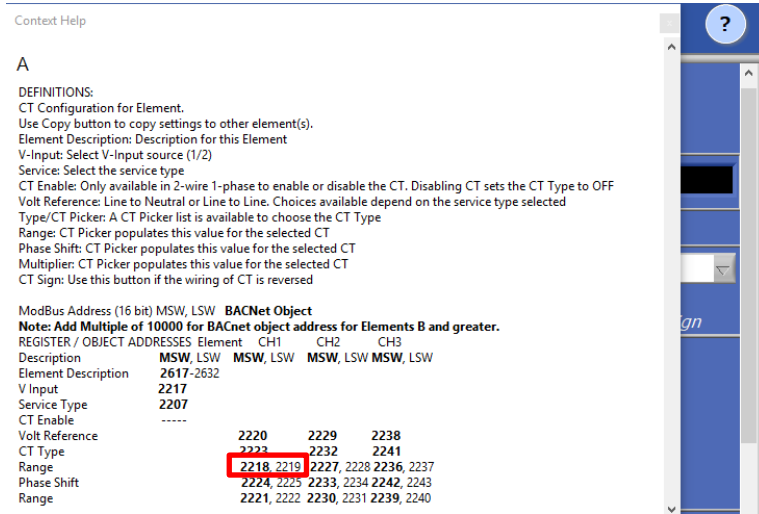

The desired control registers are 2218 (MSW) and 2219 (LSW)

Convert the register addresses of interest into hexadecimal notation (if required)

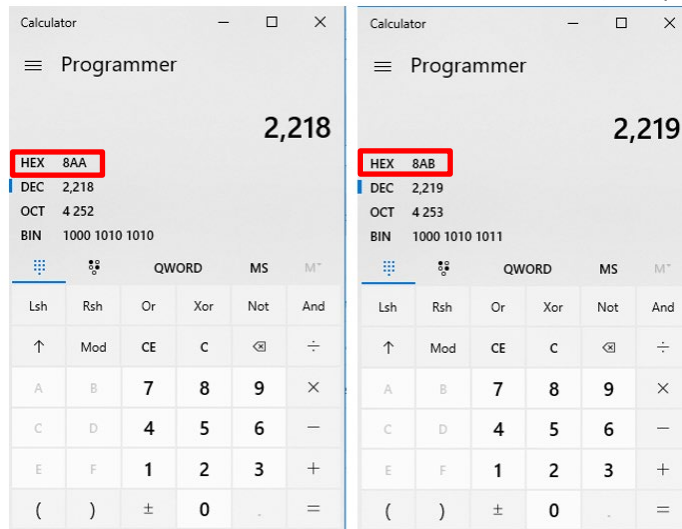

STEP 3) Calculate the CRC-16 (Modbus RTU) for the expression. There are several variations of the CRC016; ensure the one you are using is for Modbus. The CRC is entered LSB first.

Enter the Entire Expression into a CRC Calculator (a web utility can be helpful)

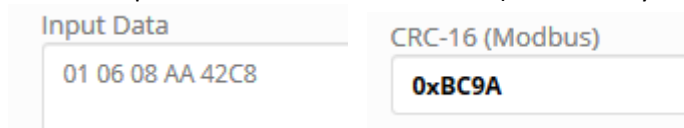

Step 4) Putting it all together

VIA MODBUS RTU (SERIAL) USING FUNCTION CODE 6 / WRITE SINGLE REGISTER

ID FC ADDR DATA CRC (note CRC order is swapped)

01 06 08 AA **42 C8** 9A BC

01 06 08 AB **00 00** FA 4A

VIA MODBUS RTU (SERIAL) USING FUNCTION CODE 16 / WRITE MULTIPLE REGISTER

ID FC ADDR #REGS LN DATA0 DATA CRC

01 10 08 AA 00 02 04 **42 C8 00 00** 8B EE

VIA MODBUS TCP (ETHERNET) USING FUNCTION CODE 6 / WRITE SINGLE REGISTER

TXNID PROID LENGT ID FC ADDR DATA (TXNID will be arbitrary)

01 87 00 00 00 06 01 06 08 AA **42 C8**

01 88 00 00 00 06 01 06 08 AB **00 00**

VIA MODBUS TCP (ETHERNET) USING FUNCTION CODE 16 / WRITE MULTIPLE REGISTER

TXNID PROID LENGT ID FC ADDR #REGS LN DATA0 DATA1

01 87 00 00 00 0B 01 10 08 AA 00 02 04 **42 C8 00 00**

COMMANDS REQUIRING A PROCESSOR RESET

Register manipulation of communication protocols or addressing require that the PSHD performs a “soft reset” in order to take effect. Register 2100 can receive a user command to facilitate this process. BACnet users write a “1” and Modbus users write “1234” to affect a soft reset. The PSHD reboot time is approximately 10 seconds.

See the Modbus examples document on the DENT Instruments web site or included with your electronic documentation for additional support on programming Modbus. The following online resources are also helpful (DENT Instruments has no affiliation with any of these organizations).

- http://Modbus.org/docs/PI_MBUS_300.pdf
- <http://www.Modbustools.com/Modbus.html>
- <http://www.simplyModbus.ca/TCP.htm>
- <http://www.tahapaksu.com/crc/>

Windows Calculator (Programmer mode)

BACnet

Building Automation and Control Network (BACnet) protocol was developed under the auspices of the American Society of Heating, Refrigerating and Air-Conditioning Engineers (ASHRAE) and is recognized as an American National, European, and ISO global standard.

BACnet Device ID: All device IDs on a BACnet network must be unique. Refer to the section “Serial Protocols” and refer to the Register List for additional information

Serial



The PSHD Serial version supports writable `max_master`, MS/TP address, `max_info_frames` properties in the device object for MS/TP networks. For best network performance, the `max_master` should be set to the highest MS/TP MAC address on the network. The MS/TP address (object 1069) must be unique on the MS/TP network. The `max_info_frames` does not need to be changed in most installations.

Ethernet



Ethernet versions can register as Foreign Devices to a BBMD. **BBMD** stands for *BACnet/IP Broadcast Management Device*. The BBMD IP address can be set from ViewPoint HD or through character string object 2264. A value of 0.0.0.0 disables foreign device registration. This process requires a processor soft reset.

BACNET SEGMENTATION

The PSHD meter does not support BACnet Segmentation. Segmentation is required when the requested data is longer than the underlying data packet size limitations of the protocol, i.e., the Maximum Transmission Unit (MTU). The MTU for BACnet MS/TP is 480 bytes and for BACnet/IP it is 1476 bytes. This means that some objects with large data arrays will not fit within a packet. This limitation effectively means that some BACnet client software cannot read the Structured View Object List. In this case the BACnet client structured view mode may need to be disabled and the standard flat object view will need to be used instead, particularly with BACnet MS/TP.

BACNET STRUCTURED VIEW

The PSHD meter supports the Structured View (SV) object container. If this option is supported in the BACnet exploring tool, objects will be grouped logically into elements which can be named to reflect electrical or physical locations, followed by system objects, as shown below for a PS12 having elements A-D.

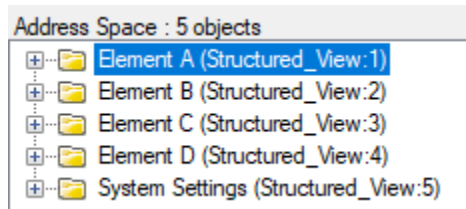

Within each element, Structured View lists the BACnet objects by Object Type and then by numeric number as shown below. In addition, objects for elements are grouped in a “hotel room” scheme. That is, Element A (and system objects) have a range from 0-9999, Element B 10000-19999, Element C 20000-29999, to Element P on the PS48HD 150000-159999. Some BACnet explorer tools have additional sorting capabilities.

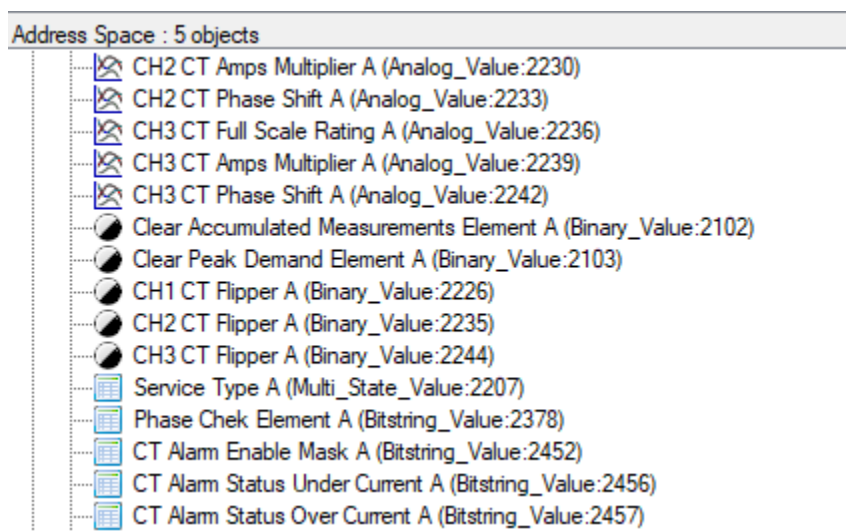

PSHD Supported BACnet Object Types		
Object Type	Abbr	Typical Usage
Analog Input:	AI	Meter Readings (floating point numeric inputs)
Analog Value:	AV	Analog User Settings (floating point numeric outputs)
Binary Value:	BV	User Boolean Settings
Multi State Value:	MSV	Enumerated Settings
BitString Value:	BSV	Bitfield Status Words and Settings
Positive Integer Value:	PIV	Restricted Range User Settings
Character String Value:	CSV	User Text string settings

The following online BACnet resource is also helpful.

- <http://www.bacnet.org/>

APPENDIX A—PSHD LCD USER INTERFACE MENU NAVIGATION

ABOUT METER (MULTI CIRCUIT PSHD METERS)

The complete LCD navigation map is shown in diagram form in the next few pages. The “About Meter” menu is the most commonly accessed item which requires 5 down presses or 1 up (rolling menu) to access.

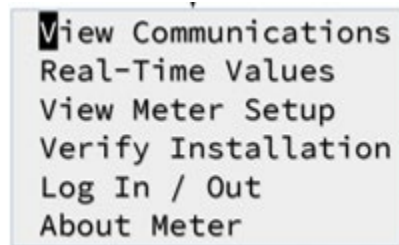

The “About Meter” menu contains the following items which are displayed 4 lines at a time and accessed by using the ^ v keys on the front display (PS12HD, PS24HD, and PS48HD). Information for the PS3HD is similar and is accessed by using the navigation wheel.

PS12HD v2.00	Model and version
Serial: P121501001	Serial number
LAN: Connected	State of LAN connection
IP: 10.1.1.1	Current IP address
MC 00:0D:63:00:00:00	MAC Address
Line Frequency: 60.0	Current line frequency
DENT Instruments	Manufacturer name
Copyright (c) 2018	Copyright notice
Protocol: Modbus	Communication protocol
Modbus Address: 1	Modbus address
Modbus Port: 502	Modbus port
MSTP Address: 1	MSTP address
Baud Rate: 9600	RS485 baud rate
DHCP: ON	Current DHCP Setting
BACnet Port: 47808	BACnet Port
BACnet DevID: 527000	BACnet Device ID
Pulse In 1: 0.0	Channel 1 pulse accumulator
Pulse In 2: 0.0	Channel 2 pulse accumulator
Pulse In 3: 0.0	Channel 3 pulse accumulator
Pulse In 4: 0.0	Channel 4 pulse accumulator
System Descriptor:	System description
PS12HD	set by user
UTC Date / Time:	Current time in UTC (GMT)
2018-04-24 10:04:08	

MENU NAVIGATION (MULTI CIRCUIT PSHD METERS)

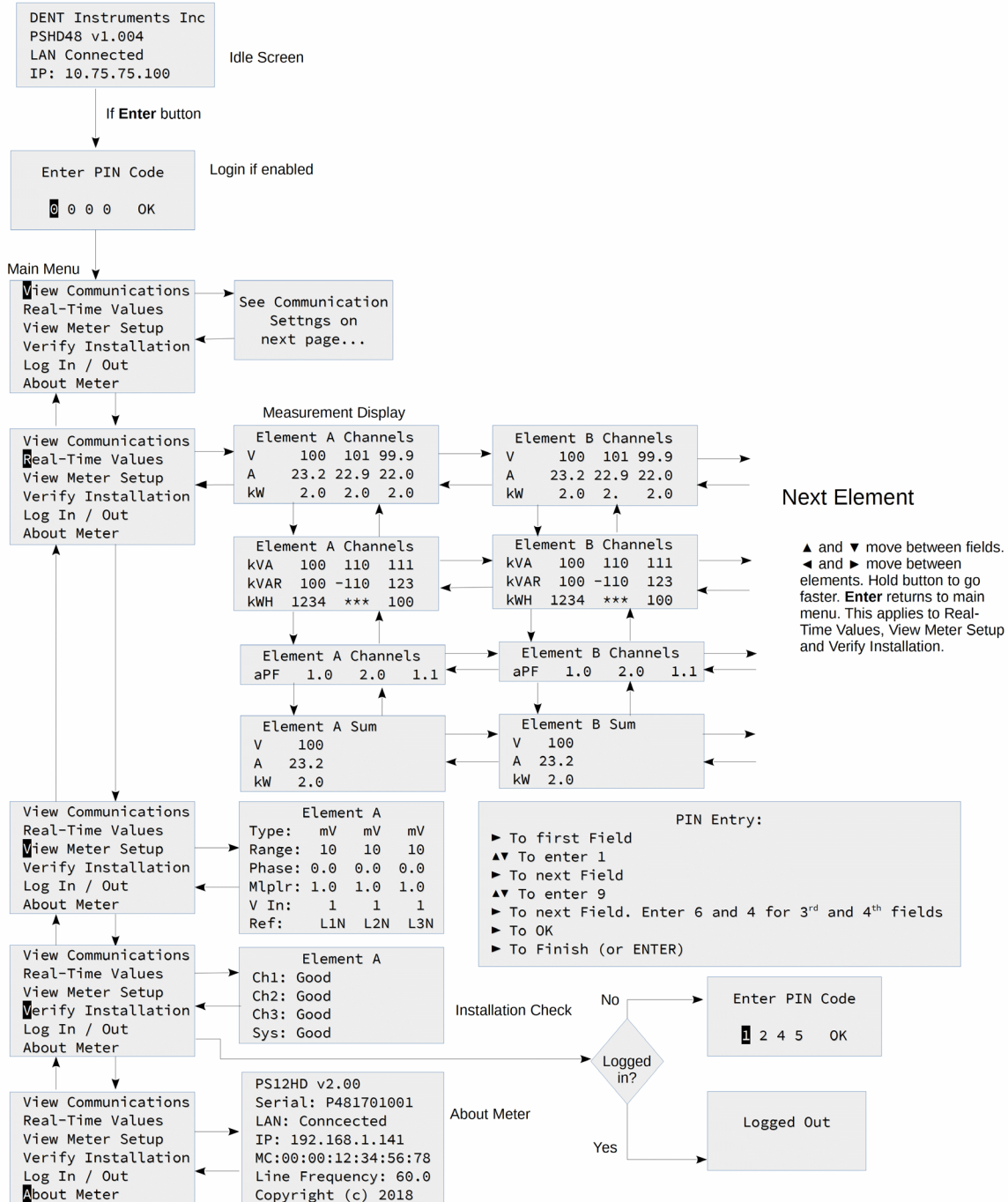

COMMUNICATION NAVIGATION (MULTI CIRCUIT PSHD METERS)

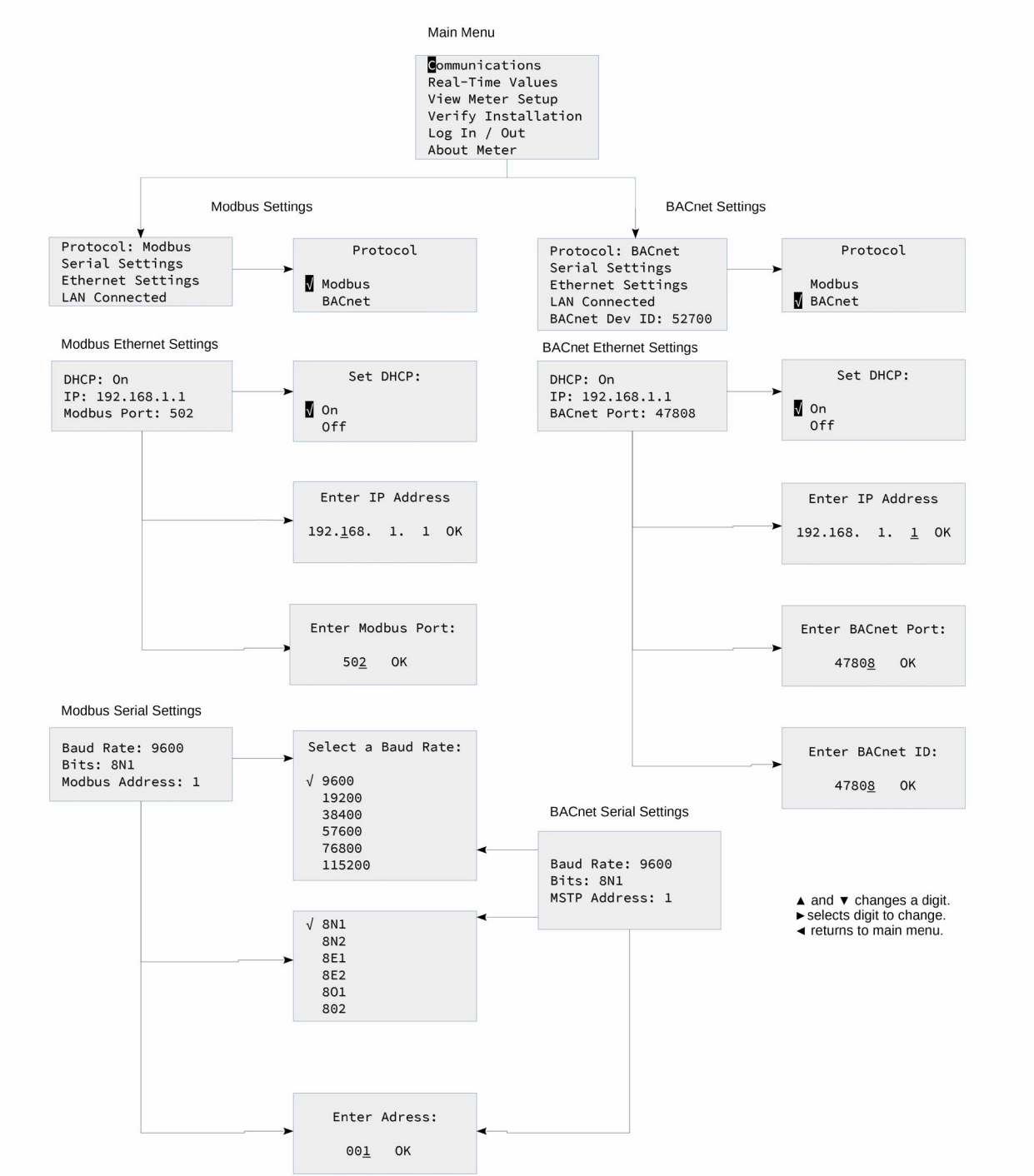

NAVIGATION (PS3HD METERS)

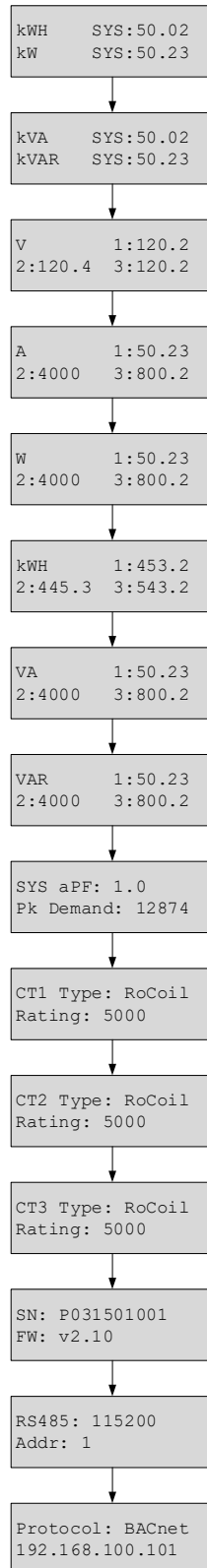

APPENDIX B—ENCLOSURE DIMENSIONS

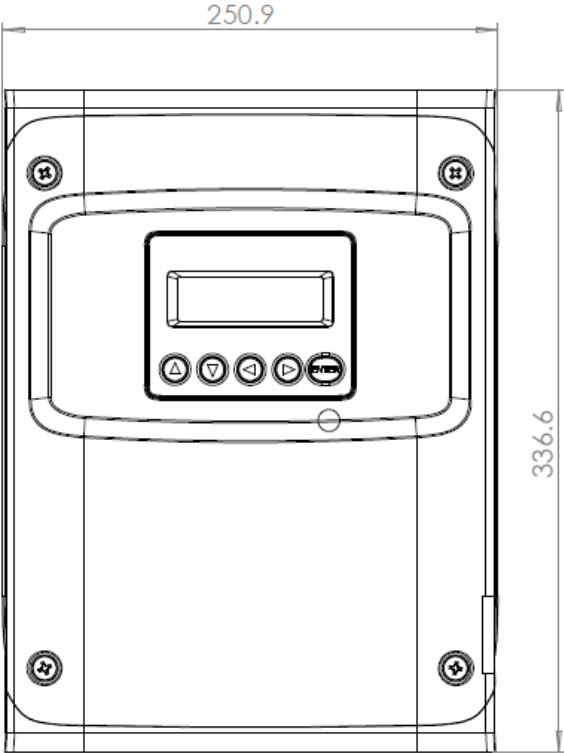

PS24HD/PS48HD Enclosure Dimensions

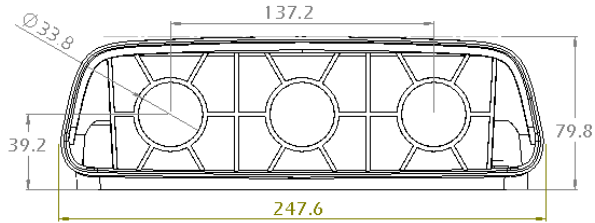
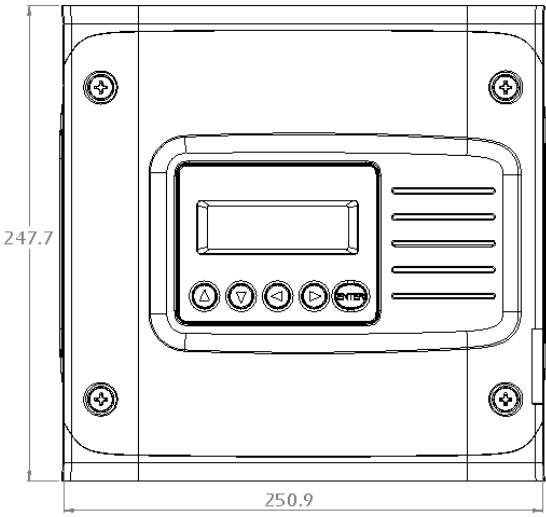

PS12HD Enclosure Dimensions

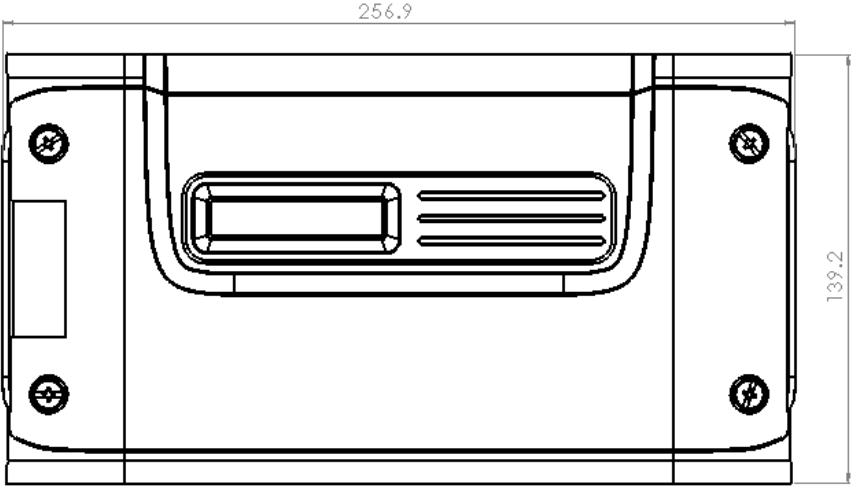

PS3HD Wall Mount Enclosure Dimensions

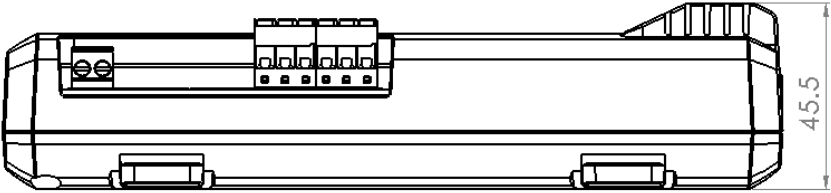
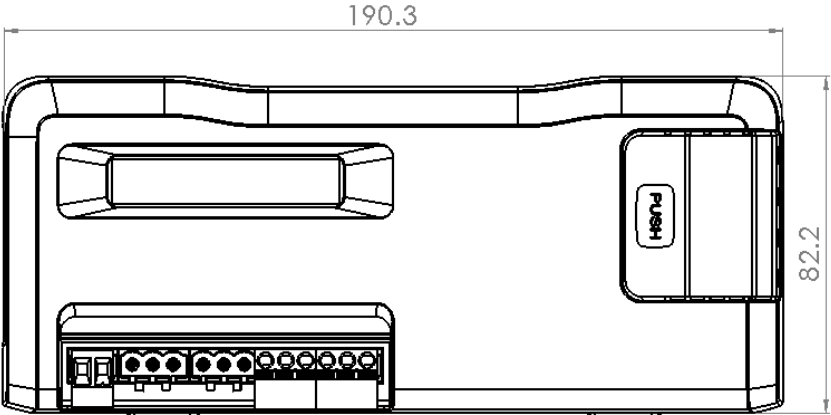

PS3HD DIN Rail Enclosure Dimensions

APPENDIX C—MOUNTING TEMPLATES

Enclosure Internal Mounting Hole Locations (Not to Scale)

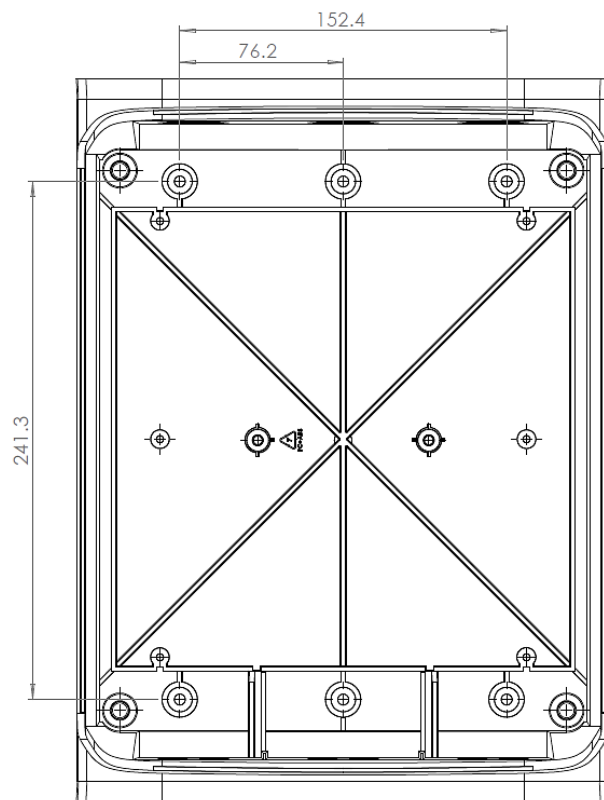

PS24HD/PS48HD Drill Template

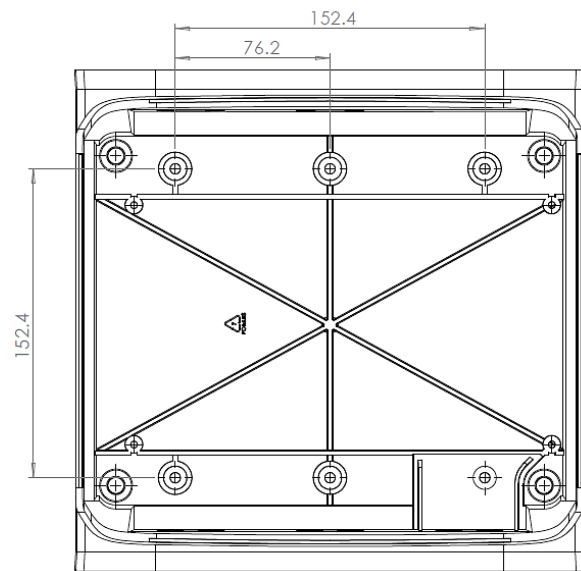

PS12HD Drill Template

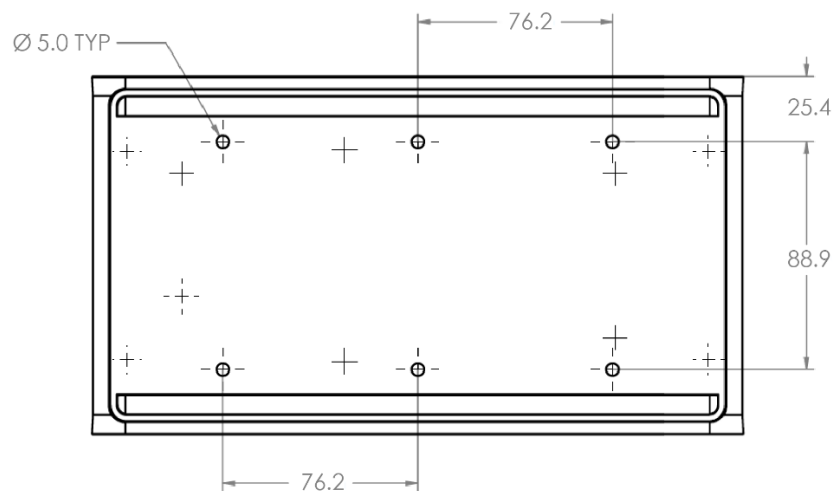

PS3HD Drill Template

Sheet Metal Plate Mounting Hole Locations (PS12HD/PS24HD/PS48HD only)

Not to Scale

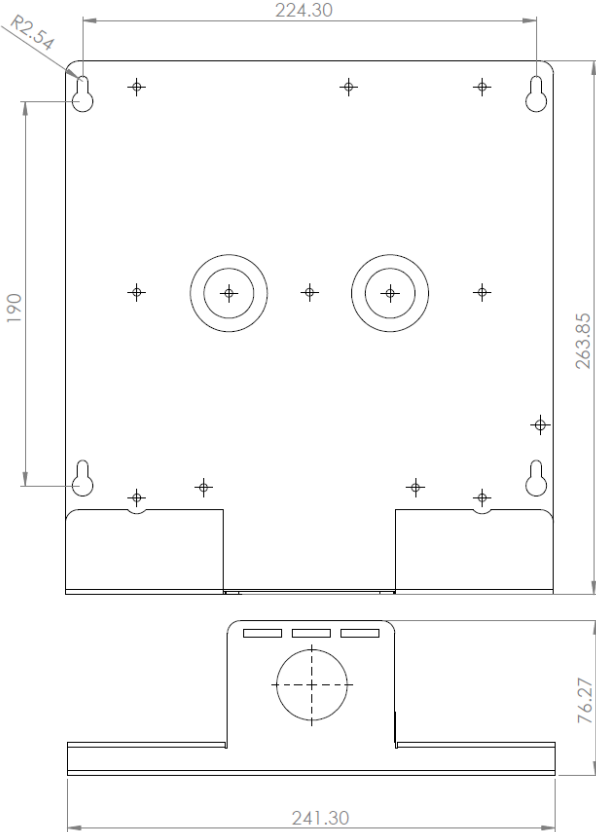



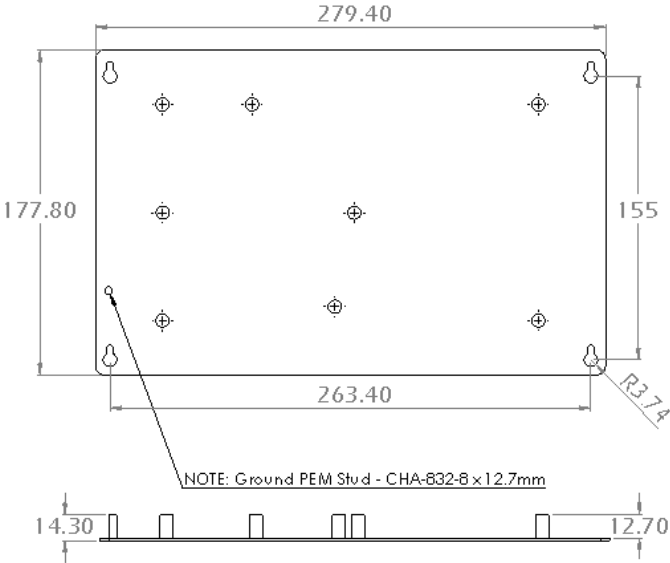







PS24HD/PS48HD Mounting Plate Drill Template



PS12HD Mounting Plate Drill Template

APPENDIX D: CT PHASE SHIFTS

Most current transformers sold by DENT Instruments have phase shifts from a few tenths of a degree up to a few degrees. For energy meters, this phase shift can produce accuracy errors. However, DENT's ViewPoint HD software can compensate for CT phase shifts to help maximize reading accuracy. DENT's CTs are listed below with their corresponding phase shift values. If you are using the desktop version of ViewPoint HD, these values will automatically be populated for you when using the CT Picker. If you are configuring your meter through the PSHD Web App, use the table below to find the correct phase shift value.

	CT Part Number	Type	Amps	Phase Shift
	CT-RGT12-0005	Millivolt	5	0.05
	CT-RGT12-0020	Millivolt	20	0
	CT-RGT12-0050	Millivolt	50	0.01
	CT-RGT12-0100	Millivolt	100	0
 HSC	CT-HSC-020	Millivolt	20	1.11
	CT-HSC-050	Millivolt	50	1.02
 HMC	CT-HMC-100	Millivolt	100	0.26
	CT-HMC-200	Millivolt	200	0.22
	CT-SRS-005	Millivolt	5	0.1
	CT-SRS-050	Millivolt	50	0.02
	CT-SRL-100	Millivolt	100	0.09
	CT-SRL-200	Millivolt	200	0.1
	CT-SRL-400	Millivolt	400	0.01
 SCS	CT-SCS-0050	Millivolt	50	3.75
	CT-SCS-0100	Millivolt	100	2.7
 SCM	CT-SCM-0100	Millivolt	100	2.17
	CT-SCM-0200	Millivolt	200	1.9
	CT-SCM-0400	Millivolt	400	1.23
	CT-SCM-0600	Millivolt	600	1.47
 SCL	CT-SCL-0600	Millivolt	600	0.53
	CT-SCL-1000	Millivolt	1000	0.51
	CT-CON-0150EZ	Millivolt	150	2.05
	CT-CON-1000	Millivolt	1000	0.44
	CT-R16-A4	RöCoil	4000	0
	CT-R24-A4	RöCoil	4000	0
	CT-R36-A4	RöCoil	4000	0
	CT-R47-A4	RöCoil	4000	0
	CT-R72-1310	RöCoil	4000	0

APPENDIX E: READ ME: VIEWPOINT HD INSTALLATION



Please follow the installation steps below for **NEW INSTALLATIONS**, **UPGRADE INSTALLATIONS**, or **CUSTOM INSTALLATIONS**. If your installation process is trying to access external resources or drivers, STOP – something is wrong! Refer to the Troubleshooting section below before proceeding.

NEW INSTALLATIONS: For Users Where No Prior Version of ViewPoint HD Has Been Installed

1. Copy the “MEDIA DISTRIBUTION” folder to your local hard drive. Installations attempted from Thumb Drives or across a Network may not be successful.

 DISTRIBUTION_DENT_6_30_2020	6/24/2020 7:55 AM	File folder
---	-------------------	-------------

2. Locate and double-click on the “Run Me to Install ViewPoint HD.bat” batch file (highlighted below).

Name	Date modified	Type	Size
 Install Files	6/4/2020 10:13 AM	File folder	
 READ ME - PowerScout HD Installation Guide.doc	6/25/2020 9:45 AM	Microsoft Word 9...	44 KB
 Run Me to Install ViewPoint HD.bat	9/18/2018 10:56 AM	Windows Batch File	1 KB

The batch file installs both the application and drivers needed for ViewPoint HD. The batch file will create a folder called “ViewPoint HD” on the root of the C drive. This folder will contain customization features for your viewer and be the default location for configuration files and retrieved log data.

3. Follow the prompts <NEXT>, <FINISH>. This process should take about 1 minute.

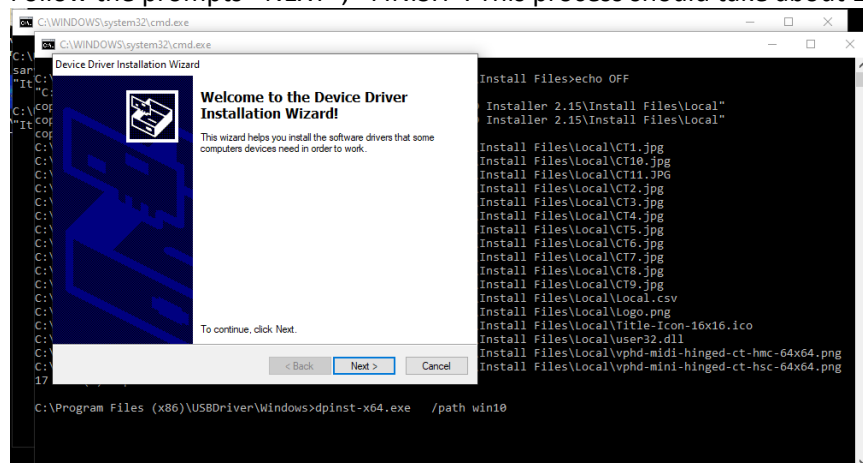

SOFTWARE UPDATE: For Users with ViewPoint HD Software Already Installed

Installing ViewPoint HD “over the top” of an existing Viewer may not replace all the support files with the current version. Therefore, additional steps must be taken prior to attempting to install an updated version of ViewPoint HD.

Before running the installer, take the following steps:

1. Locate the ViewPoint HD application within Windows “Program and Features”
 - a. Right-click on the program in the Windows Start Menu and select “Uninstall”

[Uninstall or change a program](#)

To uninstall a program, select it from the list and then click Uninstall, Change, or Repair.

Name	Publisher	Installed On	Size	Version
ViewPoint HD	DENT Instruments	6/25/2020	28.0 MB	2.0.0

2. Delete the ViewPoint HD folder from the C:\ drive
3. Proceed with the steps listed under NEW INSTALLATIONS.
 - a. Your installation will skip the installation of drivers and instead show this window:

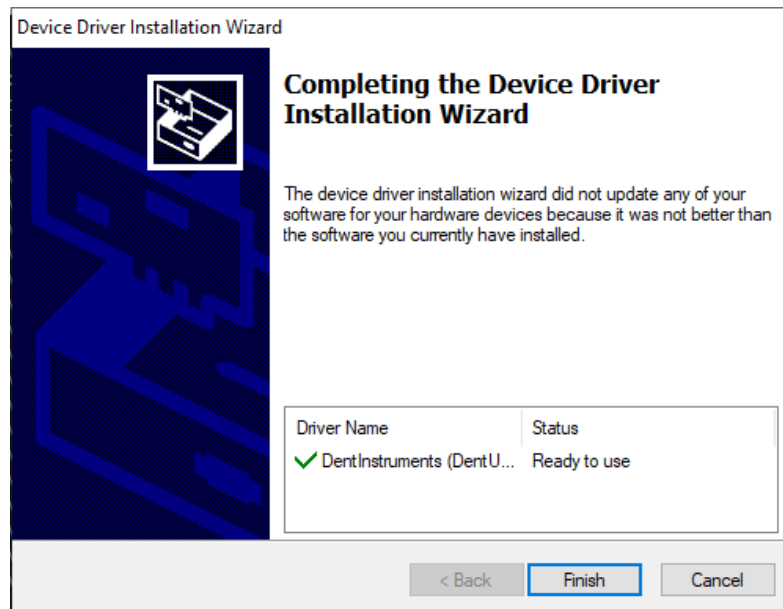

- a.
 - b. ViewPoint HD will auto-launch if the installation is successful.

CUSTOM INSTALLATION: For Users Who Cannot Use the BATCH File

If your computer requires installations within the C:\Program Files (x86) folder structure, or other designated drives, the installation can be performed using the Windows Tools. The user will need to install the required drivers as a separate process.

Within the ViewPoint HD Installer Directory, there is a folder alongside the batch file.

Name	Date modified	Type	Size
Install Files	6/24/2020 1:44 PM	File folder	
Run Me to Install ViewPoint HD.bat	9/18/2018 10:56 AM	Windows Batch File	1 KB
UPGRADE INSTALLATION READ ME.txt	2/22/2019 10:37 AM	Text Document	1 KB

The contents of this folder contain supporting documents.

Name	Date modified	Type	Size
bin	4/8/2020 12:45 PM	File folder	
license	4/8/2020 12:54 PM	File folder	
Local	6/23/2020 3:47 PM	File folder	
LVRTE	4/8/2020 1:13 PM	File folder	
supportfiles	4/8/2020 1:13 PM	File folder	
nidist.id	6/24/2020 9:16 AM	ID File	1 KB
setup.exe	6/24/2020 9:16 AM	Application	1,403 KB
setup.ini	6/24/2020 9:16 AM	Configuration sett...	2 KB

Install the LabVIEW Run Time Engine first using setup.exe in the LVRTE folder shown below:

This PC > Desktop > ViewPoint HD Installer 2.15 > Install Files > LVRTE

Name	Date modified	Type	Size
Bin	4/8/2020 12:57 PM	File folder	
Licenses	4/8/2020 12:59 PM	File folder	
Products	4/8/2020 1:13 PM	File folder	
nidist.id	11/2/2017 2:19 AM	ID File	1 KB
patents.txt	8/15/2017 3:51 AM	Text Document	24 KB
setup.exe	11/2/2017 2:01 AM	Application	1,410 KB
setup.ini	11/2/2017 2:19 AM	Configuration sett...	28 KB

Then install the Viewer application software by running the setup.exe from the location shown below:

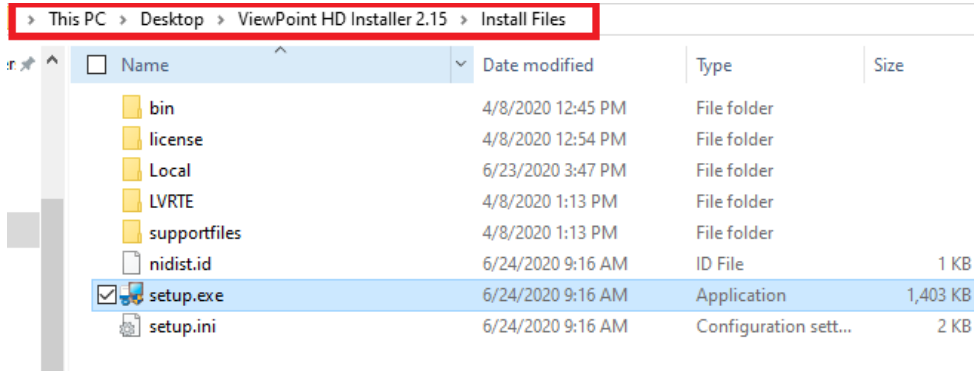

This will launch the Windows Installation Wizard and allows users to change the installation directory.

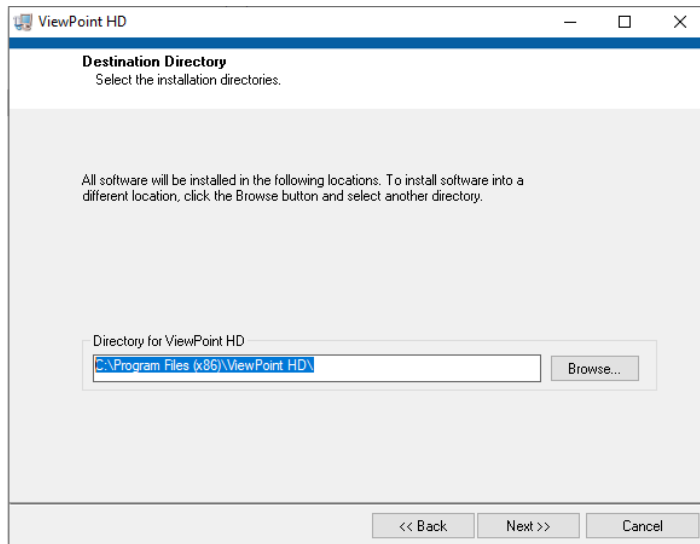

Follow the prompts to complete the installation.

Create a folder named ViewPoint HD in the C: directory and copy the folder named Local (shown below) to the newly-created C:\ViewPoint HD folder.

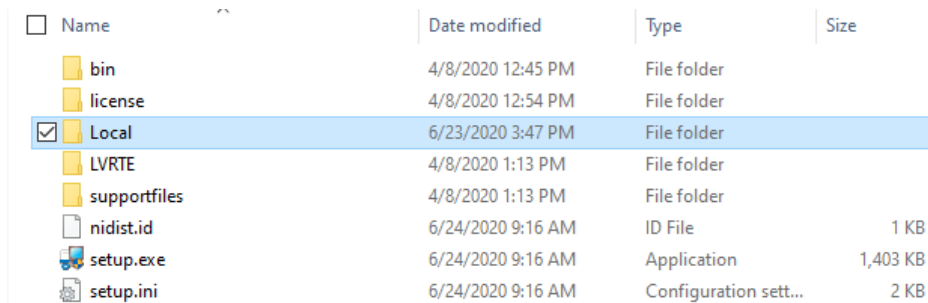

TROUBLESHOOTING

You will need to have **administrative privileges** on your PC to properly install the software. This ensures that Windows permissions are in place to allow the software to access or create required directories.

1. Checking for User Account Permissions

- a. Access the **Control Panel** on your computer
- b. Click on **User Accounts**
- c. **Confirm Permission**
 - i. User types are Administrator, Standard, and Guest



2. Install as Administrator

If your user profile is not listed as an Administrator, some installations allow a temporary permission as follows:

- a. Right-click on the "Run Me to Install ViewPoint HD.bat" and select "Run as administrator"

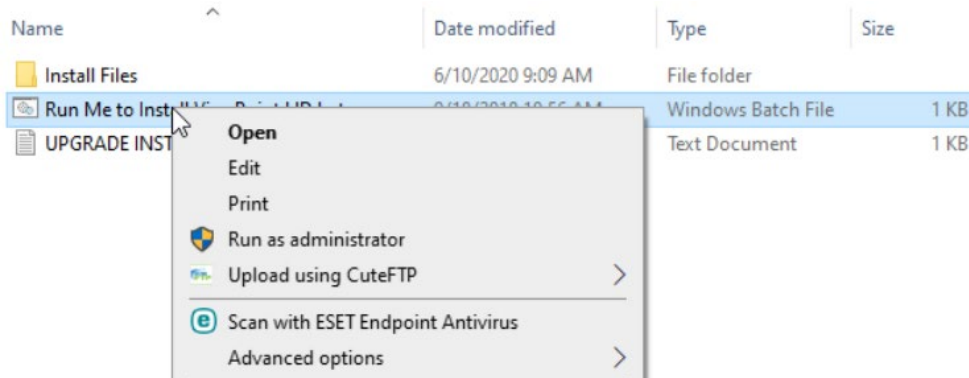

APPENDIX F—PSHD TECHNICAL SPECIFICATIONS

Specification	Description
Service Types	Single Phase, Split Phase, Three Phase-Four Wire (WYE), Three Phase-Three Wire (Delta)
Voltage Channels	90-346 Volts AC Line-to-Neutral, 600V Line-to-Line, CAT III. Two voltage reference inputs (PS48HD only)
Current Channels	3 (PS3HD) or 12 (PS12HD) or 24 (PS24HD) or 48 (PS48HD) channels, 0.525 VAC max, 333 mV CTs, 0-4,000 Amps depending on current transducer
Maximum Current Input	150% of current transducer rating (mV CTs) to maintain accuracy. Measure up to 4000A with RōCoil CTs.
Measurement Type	True RMS using high-speed digital signal processing (DSP) with continuous sampling
Line Frequency	50/60 Hz (45 - 70 Hz measurable range) – measurement taken L1-N
Power	From L1 Phase to L2 Phase. 90-600VAC RMS CAT III 50/60Hz, 500mA AC Max Use of 12-volt auxiliary output requires 100 VAC minimum input voltage.
AC Protection	0.5A Fuse 200kA interrupt capacity
Power Out	PS12HD/PS24HD/PS48HD only: Unregulated 12VDC output, 200 mA, self-resetting fuse
Waveform Sampling	1.8 kHz
Parameter Update Rate	1 second
Interval Data Recording	Energy (kWh) values are recorded every 15 minutes for 63 days (downloadable log) Each record is time stamped.
Measurements	Volts, Amps, kW, kVAR, kVA, aPF, dPF, kW demand, kVA demand, Import (Received) kWh, Export (Delivered) kWh, Net kWh, Import (Received) kVAh, Export (Delivered) kVAh, Net kVAh, Import (Received) kVARh, Export (Delivered) kVARh, Net kVARh, THD, Theta, Frequency. All parameters for each phase and system total.
Accuracy	0.2% ANSI C12.20-2015 Class 0.2
Resolution	Values reported in IEEE-754 single precision floating point format (32 bit)
Indicators	PS3HD: Standard 2-line display, tri-color backlight (PhaseChek™) PS12HD/PS24HD/PS48HD: Optional 4-line display, tri-color backlight (PhaseChek™)
Alarm Output	User-configurable alarm with relay output
Pulse Inputs	PS3HD - None PS12HD - 4 inputs PS24HD – 2 inputs PS48HD - 2 inputs 3.3V sourcing voltage (current limited) to user dry contact pulse output Maximum Pulse Rate 10 HZ (50 msec minimum transition time)

Specification	Description
Communication	
Hardware	RS-485, Ethernet, and USB
Supported Protocols	Modbus RTU or BACnet Master Slave Token Passing protocol (MS/TP) Modbus (using SunSpec IEEE-754 single precision floating point model)
Max Communication Length	1200 meters with Data Range of 100K bits/second or less
RS-485 Loading	1/8 unit
Communication Rate (baud)	Modbus: 9600 (Default), 19200, 38400, 57600, 76800, 115200 BACnet: 9600, 19200, 38400, 76800
Data Bits	8
Parity	None, Even, Odd
Stop Bit	2, 1
Termination	None provided
Data Formats	Modbus RTU, BACnet MS/TP, Modbus TCP or BACnet IP
Mechanical	
Wire Connections	12-28 AWG 600 VAC, Voltage connection must be #14 AWG or larger & 600 VAC rated
Mounting	Enclosure or Panel Mount
High Voltage Cover	IP30. Included with all models except PS12HD-P-D-N
Operating Temperature	-20 to + 60° C (-4 to 140° F) (the colder the temperature the more voltage needed to power the board)
Humidity	5% to 95% non-condensing
Enclosure	ABS Plastic, 94-V0 flammability rating Conduit Connections: 1" (PS12HD/PS48HD Wall Mount enclosures) or ½" (PS3HD Wall Mount enclosure)
PS24HD/PS48HD Dimensions	(L) 33.7cm x (W) 25.1cm x (H) 8.0 cm (13.3" x 9.8" x 3.1") (enclosure version) (L) 26.2cm x (W) 24.1cm x (H) 8.0 cm (10.3" x 9.5" x 3.1") (mounting plate version)
PS12HD Dimensions	(L) 24.8cm x (W) 25.1cm x (H) 8.0 cm (9.8" x 9.8" x 3.1") (enclosure version) (L) 17.8cm x (W) 26.3cm x (H) 8.0 cm (7.0" x 10.4" x 3.1") (mounting plate version)
PS3HD Dimensions	(L) 19.1cm x (W) 8.2cm x (H) 3.8cm (7.5" x 3.2" x 1.5") (DIN Rail Version) (L) 25.7cm x (W) 14.0cm x (H) 5.4cm (10.1" x 5.5" x 2.1") (Wall Mount Version)
ViewPoint™ HD Minimum System Requirements	
Operating System	Windows® 7, Windows® 8, Windows® 10
Communications Port	USB or Ethernet connection

Specification	Description
Certifications	
FCC Compliance	This device has been tested and found to comply with the limits for a Class A digital device, pursuant to part 15 of the FCC Rules. These limits are designed to provide reasonable protection against harmful interference when the equipment is operated in a commercial environment. This equipment generates, uses, and can radiate radio frequency energy and, if not installed and used in accordance with the instruction manual, may cause harmful interference to radio communications. Operation of this equipment in a residential area is likely to cause harmful interference in which case the user will be required to correct the interference at user's own expense.
Safety	<p>The following are UL Recognized:</p> <ul style="list-style-type: none"> ▪ PS12HD-B-y-z ▪ PS12HD-P-y-z ▪ PS24HD-P-y-z ▪ PS48HD-B-y-z ▪ PS48HD-P-y-z <p>The following are UL Listed:</p> <ul style="list-style-type: none"> ▪ PS12HD-C-y-z ▪ PS48HD-C-y-z ▪ PS24HD-C-D-N ▪ PS3HD-C-D-N ▪ PS3HD-R-D-N <p>Conforms to UL Std 61010-1, 3rd Edition, UL 61010-2-30:2010 Certified to CSA Std C22.2 No. 61010-1, 3rd Edition</p>
CE	LVD (EN61010-1) EMC (EN61326-1) RoHS 2 (EN50581)